

-38Inf kg

1.	BARROSO LOPEZ, Luis	MAD
2.	GRACIA GARIJO, Gorka	NAV
3.	CAMPOS VARON, Jorge	GAL
3.	GUTIERREZ NAVARRO, Aitor	MAD
5.	MACHUCA VALLINOT, Miguel Angel	MAD
5.	NOVILLO MANTECON, Victor	MAD
7.	GIMENEZ LLAMAS, David	VAL
7.	IBANEZ AZNAR, Joel	ARA

-42Inf kg

1.	QUINTANILLA MARTIN, Sergio	MAD
2.	CABRER LLODRA, Jaume	BAL
3.	GONZALEZ FELLMANN, Mikael	CAN
3.	GUTIERREZ NAVARRO, Iker	MAD
5.	CAPRANI DE DIEGO, Guillermo	VAL
5.	OGANESYAN, Daniil	CAT
7.	ANTON ZURDO, Alvaro	CLE
7.	GARCIA SANTANA, Ruben	CAN

-46Inf kg

1.	BECHDEJU COLL, Marc	CAT
2.	ADRIAN BALTOI, Carlos	VAL
3.	GARCIA SANTANA, David	CAN
3.	MIER AROCO, Roberto	MAD
5.	MORALES BILBAO, Enrique	CTB
5.	SUAREZ ARTILES, Giovanni	CAN
7.	CAMACHO ALVAREZ, Oscar	AST
7.	PORTELA RIVEIRO, Miguel	GAL

-50Inf kg

1.	GIMENO TRICOT, David	VAL
2.	LOPEZ DIAZ, Jesus	AND
3.	MARTIN GOMEZ, Asier	CLE
3.	TALTALVULL MARI, Dami	BAL
5.	MARQUEZ VILLAVARDE, Javier	RIO
5.	ROMERO QUEVEDO, Ruyman	CAN
7.	ROSAL RODRIGUEZ, Bruno	GAL
7.	SAIZ JUAN, Hugo	MAD

-55Inf kg

1.	PINA RODRIGUEZ, Maximo	GAL
2.	HERNANDEZ TRUJILLO, Johan Luis	CAN
3.	AGUAYO ROMAN, Alfonso	CLE
3.	MARTINEZ CALLEJON, Jorge	CLM
5.	GADEA JUAN, David	VAL
5.	SANGENIS GRAU, Pau	CAT
7.	ARROYO MORENO, Eduardo	MAD
7.	MORALES MONTERO, Christian	MAD

-60Inf kg

1.	MATEOS SANCHEZ, Gonzalo	MAD
2.	SANGIL SERRANO, Pablo	BAL
3.	MENENDEZ RUBIERA, Alfredo	AST
3.	RODRIGUEZ ROMERO, Martin	CLE
5.	FERNANDEZ LLORIS, Emilio	VAL
5.	RUIZ DE LA CUESTA FABREGAT, Eduardo	ARA
7.	ABEJON PEREZ, Alberto	AST
7.	CHAVEZ MENDOZA, Alejandro	CAN

-66Inf kg

1.	BA, Kindi	CAT
2.	LE MONZE, Antoine	CAT
3.	KARATAYEU, Ivan	VAL
3.	TIMCHUK, Illya	VAL
5.	LAZARO MOLINA, Sergio	MAD
5.	VALLS MAYOR, Ermias	CAT
7.	FERNANDEZ GARCIA, Pedro Jose	MUR
7.	ROLDAN BELTRAN, Sergio	MAD

+66Inf kg

1.	CARRERA SALSAMENDI, Amets	VAS
2.	CASCALES GONZALEZ, Pablo	CLM
3.	VILLANUEVA ASENJO, Hugo	RIO
3.	ZAMBRANO CEDENO, Maikel Raul	NAV
5.	ILLAN MORALES, David	MAD
5.	MOLINA INOJOSA, Kaisan	CAT
7.	ARJONILLA QUINTANA, Manuel	MAD
7.	SALVADO CARRILLO, Diego	GAL

-46Cad kg

1.	SOLA DELGADO, Ivan	NAV	
2.	VERA HENKEL, Fabio	BAL	
3.	GAMAZO DUQUE, Manuel	MAD	
3.	IONESCU, Albano	RIO	
5.	FERRER ALMANSA, Roberto	VAL	
5.	FLETA PALOS, Angel	ARA	
7.	CEBRIAN SANCHEZ, Alejandro	CLM	
7.	PANIZO GUTIERREZ, Ignacio	MAD	

-50Cad kg

1.	GOMEZ LLORENS, Pedro	VAL	
2.	BERNABEU RICO, Jaume	VAL	
3.	FERNANDEZ RODRIGUEZ, Alejandro	MAD	
3.	PEREZ HERNANDEZ, Juan Antonio	AND	
5.	OBREGON MUNOZ, Felix David	RIO	
5.	SENENT SORIANO, Luis	VAL	
7.	BERMEJO BASURDE, Unai	VAS	
7.	CARRILERO VILLODRE, Alvaro	CLM	

-55Cad kg

1.	FERNANDEZ TENREIRO, Alejandro	GAL	
2.	TORO SOLER, Julen	NAV	
3.	GALLEGO SAEZ, Daniel	MAD	
3.	PALACIOS CALZADO, Sergio	NAV	
5.	PORRAS FERREIRO, Gaizka	VAL	
5.	SANTACREU GARCIA, Pau	CAT	
7.	AZNAL SANTAREN, Alexis	MAD	
7.	LLOPE GARCIA, Iyan	AST	

-60Cad kg

1.	LOPEZ LOPEZ, Pol	CAT	
2.	GOIKOETXEA ALONSO, Aitor	VAS	
3.	ESTEVAS-GUILMAIN MORAN, Javier	VAS	
3.	FERNANDEZ CAMPILLO, Diego	MAD	
5.	ALVEZ DUARTE, David	MAD	
5.	CASADO JURADO, David	AND	
7.	CASTRO ESTEBAN, Diego	CLE	
7.	ROMERO GONZALEZ, Adrian	GAL	

-66Cad kg

1.	PENA INSAUSTI, Javier	MAD	
2.	MORALES PUCHE, Ernesto	AND	
3.	GARCIA OBENSA, Sergio	ARA	
3.	GARCIA SANRAFAEL, Marc	CAT	
5.	CALLEJAS SANCHEZ, Juan Jose	AND	
5.	MANGAS ROMO, Marcos	CLE	
7.	BERNAL ZUBIMENDI, Martxel	VAS	
7.	RUEDA TAGLE, Javier	MAD	

-73Cad kg

1.	LE MONZE, Maxime	CAT	
2.	NIETO TRINIDAD, Daniel	EXT	
3.	CLAVERAS RETANA, Julian	VAS	
3.	SANCHIS LAHIGUERA, Pablo	VAL	
5.	FERNANDEZ RODRIGUEZ, Fernando	MAD	
5.	MORALES MESA, Yone	CAN	
7.	GARCIA PEREZ, Jorge	ARA	
7.	ROMERO LOPEZ, Guillermo	MUR	

-81Cad kg

1.	BRACELI GRANERO, Javier	VAL	
2.	MAYI HEVILLA, Moises	AND	
3.	GARCIA DOMINGO, Saul	RIO	
3.	PASCUAL SAGARNA, Jon	VAS	
5.	GALINDO RODRIGUEZ, Roberto	CLM	
5.	PARECHYN, Vladislav	ARA	
7.	BARCIA BOMHOF, Hugo	VAL	
7.	PEREZ MENDIGUREN, Jordi	CAT	

-90Cad kg

1.	SANCHIS REIG, Adrian	VAL	
2.	RODRIGUEZ GALLARDO, Francisco Javier	AND	
3.	CARPINTERO SALAZAR, Sebastian	CAT	
3.	LOTERO TORRES, Hector	NAV	
5.	ALBEROLA VALVERDE, Ivan	VAL	
5.	DIEZ GONZALEZ, Nicolas	NAV	
7.	GARCIA ALONSO, Raul	AST	
7.	LANDA VERA, Enrique	MAD	



Campeonato de España Escolar 2017

Valencia (ESP), 06-07 May 2017

Hombres

Resultados

+90Cad kg

1.	CALVO GARCIA, Alejandro	MAD
2.	SALVADO CARRILLO, Martin	GAL
3.	HUELGA MANZANO, Miguel	CTB
3.	LOPEZ LOPEZ, Maxi	VAL
5.	SAEZ PASCUAL, Victor Javier	MAD
5.	VLAZQUEZ MERENCIANO, Roger	CAT
7.	GUISADO SERRANO, Roberto	MAD
7.	MARIN BERDONCES, Pablo	NAV





Campeonato de España Escolar 2017

Valencia (ESP), 06-07 May 2017

Mujeres Resultados

-36Inf kg

1.	LAZARO SAIZ, Aira	CAT	
2.	LEAL PAUSANOS, Ana Julia	NAV	
3.	CID BALCELLS, Paula	CAT	
3.	GONZALEZ ARROYO, Valle	CAT	
5.	PENAS FORNE, Natalia	CAT	
5.	PUGA PRESEDO, Candela	GAL	
7.	LAVADO ZORILLA, Zaira	MAD	
7.	MARCHENA BARBAS, Andrea	MAD	

-40Inf kg

1.	ESPARZA RIVERA, Rebeca	MAD	
2.	DOMINGO AYALA, Clara	AND	
3.	BULDAIN ELIZALDE, Joane	NAV	
3.	REQUE JUNCO, Claudia	CLE	
5.	QUEROL ILARI, Isabel	CAT	
5.	ROMEU ROLDAN, Raquel	CAT	
7.	CANO VILLAMOR, Sara	MAD	
7.	ROVIRA LEON, Silvia	VAL	

-44Inf kg

1.	HINOJOSA PEREZ, Ines	ARA	
2.	PEREZ PACHECO, Veronica	GAL	
3.	BUSTILLO BUSTOS, Maria Alejandra	MAD	
3.	GARCIA PELLICER, Maria	VAL	
5.	PEREZ DE ARENAZA SAMANIEGO, Aroa	VAS	
5.	POYATO LOPEZ, Sara	MAD	
7.	MARTINEZ SUAREZ, Maria	BAL	
7.	NUNO DE LA ROSA CENTENO, Marta	MAD	

-48Inf kg

1.	TORO SOLER, Ariane	NAV	
2.	BEORLEGUI OSES, Paula	VAS	
3.	FERNANDEZ SANCHEZ, Elisa	AST	
3.	GOMEZ ANTONA, Laura	MAD	
5.	JUAN MARTINEZ, Paula	MAD	
5.	RUBIO GARCIA-SOTO, Andrea	VAL	
7.	GUERRERO CONDE, Nora	CAT	
7.	GUERRERO DONAT, Aitana	VAL	

-52Inf kg

1.	BARREIRO GONZALEZ, Alba	AST	
2.	BEAUSSE SIRO, Melany	VAL	
3.	GONZALEZ RUIZ, Agueda	MUR	
3.	KONARE SISSOKO, Deniba	VAS	
5.	CORNEJO MARTIN, Paola	CLE	
5.	MARTINEZ OCHOA, Carmen	RIO	
7.	LAGE RIVERA, Sabela	GAL	
7.	ROMERO GUTIERREZ, Irene	CAT	

-57Inf kg

1.	FERNANDEZ HERRERA, Aitana	VAL	
2.	GIMENO TRICOT, Natasha	VAL	
3.	BLANCO MATESANZ, Patricia	MAD	
3.	TORRES LUMBRERAS, Valeria	VAL	
5.	CATENA ANDUEZA, Saioa	NAV	
5.	GUTIERREZ CABEZON, Nuria	RIO	
7.	CASANAS ACEDO, Judit	CAT	
7.	LERCHUNDI SERRANO, Loraine	VAS	

-63Inf kg

1.	ETXABARRIA BILBAO, Eunáte	VAS	
2.	DIEZ RODRIGUEZ, Janire	VAS	
3.	LAFUENTE DUQUE, Leire	NAV	
3.	SALAZAR RAMOS, Ainoa	CAN	
5.	LOPEZ VAZQUEZ, Mara	GAL	
5.	RAMIREZ VICTORIA, Amparo	VAL	
7.	GARCIA ROCCO, Katerina	CLM	
7.	SOUTO GONZALEZ, Melania	AST	

+63Inf kg

1.	KALINCHUK, Maria	VAL	
2.	INSUA IGLESIAS, Noelia	GAL	
3.	JORGE MOLYTE, Manuela	GAL	
3.	SORIANO MORON, Zoe	AND	
5.	CUESTA MENENDEZ, Iria	AST	
5.	LOPEZ CARRASCO, Ainhoa	CAT	
7.	FERNANDEZ DIAZ, Noa	AST	
7.	MELIAN HERNANDEZ, Aurora	CAN	





Campeonato de España Escolar 2017

Valencia (ESP), 06-07 May 2017

Mujeres Resultados

-40Cad kg

1.	TORREGROSA PINA, Laura	VAL
2.	PRADOS BARBERO, Maria	AND
3.	CASTRO FERNANDEZ, Itziar	MAD
3.	MAYORDOMO GARCIA, Carmen	MAD
5.	CORREJES GREGORIO, Lidia	VAL
5.	MEDICES VEGA, Delia	VAS
7.	FONTECHA MUNOZ, Olga	CLE
7.	HERNANDEZ FLORES, Nayara	AND

-44Cad kg

1.	RODRIGUEZ SALVADOR, Mireia	VAL
2.	GARRIGA ORTEGA, Marina	CAT
3.	BARANDIARAN BARREIRO, Eider	VAS
3.	RODRIGUEZ CARBALLO, Lucia	GAL
5.	FARELO GONZALEZ, Nuria	BAL
5.	HERNANDEZ FLORES, Nazaret	AND
7.	MORENO DE LA LLAVE, Maria	MAD
7.	ROJAS GONZALEZ, Maria	MAD

-48Cad kg

1.	ROSET MARTIN, Paula	CAT
2.	CARAZAS HUAYANCA, Maria Lucia	VAS
3.	GOMEZ ANTONA, Gema Maria	MAD
3.	VILLALBA CAMPO, Raquel	MAD
5.	DURAN LUSTRES, Lia	GAL
5.	FALCON SANCHEZ, Zuleima	CAN
7.	MAGADAN FERNANDEZ, Mireya	AST
7.	PEREZ GREGORIO, Alba	CLM

-52Cad kg

1.	MARTIN GALLARDO, Patricia	MAD
2.	MUNOZ SOLANO, Lucia	MAD
3.	CASTELLO DIEZ, Marina	VAL
3.	GARCIA JURADO, Ana	CAT
5.	CAMPUZANO PEREZ, Marta	CLM
5.	MARTINEZ LLORET, Leyre	NAV
7.	GIL ALONSO, Carla	VAL
7.	GONZALEZ TOLEDO, Lorena	MAD

-57Cad kg

1.	OLIVER FERRA, Maria	BAL
2.	VAZQUEZ FERNANDEZ, Laura	GAL
3.	ARAIZ SANCHO, Cristina	VAL
3.	BUCUR, Alicia Carmen	RIO
5.	JUAN MARTINEZ, Alba	MAD
5.	PEREZ COLLAZO, Eva	RIO
7.	DASGUPTA, Aakriti	CAT
7.	FERNANDEZ LOPEZ, Pilar	MAD

-63Cad kg

1.	REY BURGOS, Maria	MAD
2.	CAMUS HERNAEZ, Irene	ARA
3.	GUERRERO BOLINCHES, Clara	VAL
3.	REY CHECA, Esther	MAD
5.	ETXABE ETXEBERRIA, Lorea	VAS
5.	SANCHIS FERRERO, Natalia	VAL
7.	DIAZ-FLORES BASCUNANA, Yanira	MAD
7.	VALDIVIESO ESTALRICH, Lydia	MAD

-70Cad kg

1.	TSUNODA, Ai	CAT
2.	DAVILA MONTOYA, Sara	MAD
3.	PINTADO GALLARDO, Cristina	MAD
3.	SOTILLO GOMEZ, Begona	MAD
5.	BONE IBANEZ, Ines	VAL
5.	REY CHECA, Alba	MAD
7.	CATALAN SALAS, Elena	ARA
7.	GONZALEZ DOMINGUEZ, Yailen	CAN

+70Cad kg

1.	FERNANDEZ CAMPILLO, Sara	MAD
2.	SUAREZ CABRERA, Dayami	CAN
3.	CORNELLA BUJALDON, Aina	CAT
3.	HEREDIA REYES, Maria Jose	MAD
5.	DAZA VILLA, Paula	MAD
5.	DIAZ CANTOS, Ohiana	VAS
7.	BOUSBAA DAB, Nisrim	MAD
7.	MUNOZ PEREZ, Ane	VAS





Campeonato de España Escolar 2017

Valencia (ESP), 06-07 May 2017

-38Inf kg

27 Judoka

POOL A

1	BARROSO LOPEZ, Luis	MAD	1	BARROSO LOPEZ, Luis
17			17	BARROSO LOPEZ, Luis
9	FERRER AGUEDA, Miguel	ARA	2	FERRER AGUEDA, Miguel
25	DIAZ PINERO, Francisco Javier	EXT	2	110 / 000 0:36
5	GIMENEZ LLAMAS, David	VAL	3	GIMENEZ LLAMAS, David
21	MENDOZANA LABERNIA, David	VAS	3	100 / 000 s3 3:39
13	LLOPE GARCIA, Nel	AST	4	LLOPE GARCIA, Nel
29	ECHEBERRI ARDANAZ, Esker	NAV	4	100 / 000 s3 3:34
			18	GIMENEZ LLAMAS, David
				110 / 000 1:01

POOL B

3	MSSAHAL, Ahmed	CAT	5	MSSAHAL, Ahmed
19			19	SANCHEZ GARCIA, Juan
11	SANCHEZ GARCIA, Juan	MAD	6	SANCHEZ GARCIA, Juan
27	TEBAR RUIZ, Daniel	CLM	6	110 / 000 0:14
7	CAMPOS VARON, Jorge	GAL	7	CAMPOS VARON, Jorge
23	NOVILLO MANTECON, Victor	MAD	7	010 s1 / 000 s1 3:00
15			8	RODICIO MUNIZ, Nicolas
31	RODICIO MUNIZ, Nicolas	CTB	8	
			20	CAMPOS VARON, Jorge
				120 / 000 s3 2:18

POOL C

2	GRACIA GARIJO, Gorka	NAV	9	GRACIA GARIJO, Gorka
18			21	GRACIA GARIJO, Gorka
10	BROUTIN DIEZ, Alejandro	BAL	10	BROUTIN DIEZ, Alejandro
26	RODRIGUEZ OLIVARES, Airan	CAN	10	110 s1 / 000 s2 2:52
6	FRANCISCO RUIZ, Angel	GAL	11	FRANCISCO RUIZ, Angel
22	GARCIA MERINO, Ivan	CLE	11	130 s1 / 000 1:31
14	PENA PEREZ, Miquel	CAT	12	MACHUCA VALLINOT, Miguel Angel
30	MACHUCA VALLINOT, Miguel Angel	MAD	12	000 s1 / 130 s1 2:47
			22	MACHUCA VALLINOT, Miguel Angel
				000 / 020 s1 3:00

POOL D

4	IBANEZ AZNAR, Joel	ARA	13	IBANEZ AZNAR, Joel
20			23	IBANEZ AZNAR, Joel
12	AGUIRRE ACOSTA, Alejandro	MUR	14	FOX CASTELLAR, Victor
28	FOX CASTELLAR, Victor	VAL	14	000 / 110 0:34
8	OSERIN JIMENEZ, Marcos	RIO	15	OSERIN JIMENEZ, Marcos
24	WARD ESPANA, Nicolas	AND	15	110 s1 / 000 1:28
16	PATINO MARTINEZ, Xesus	GAL	16	GUTIERREZ NAVARRO, Aitor
32	GUTIERREZ NAVARRO, Aitor	MAD	16	000 / 010 3:00
			24	GUTIERREZ NAVARRO, Aitor
				000 s3 / 120 s1 2:19

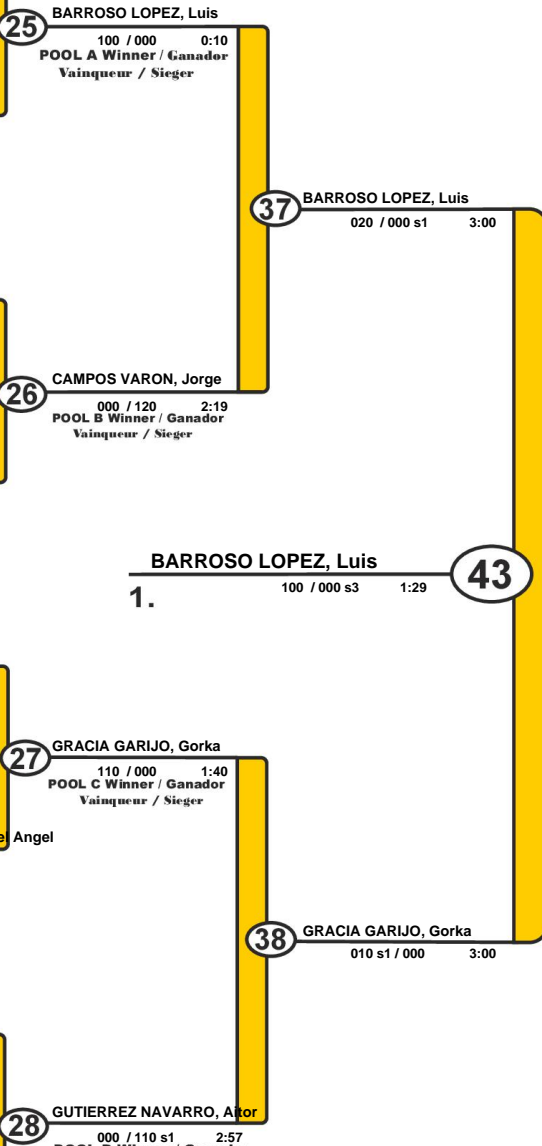

Trostrunde / Repechage / Ronda de consolación

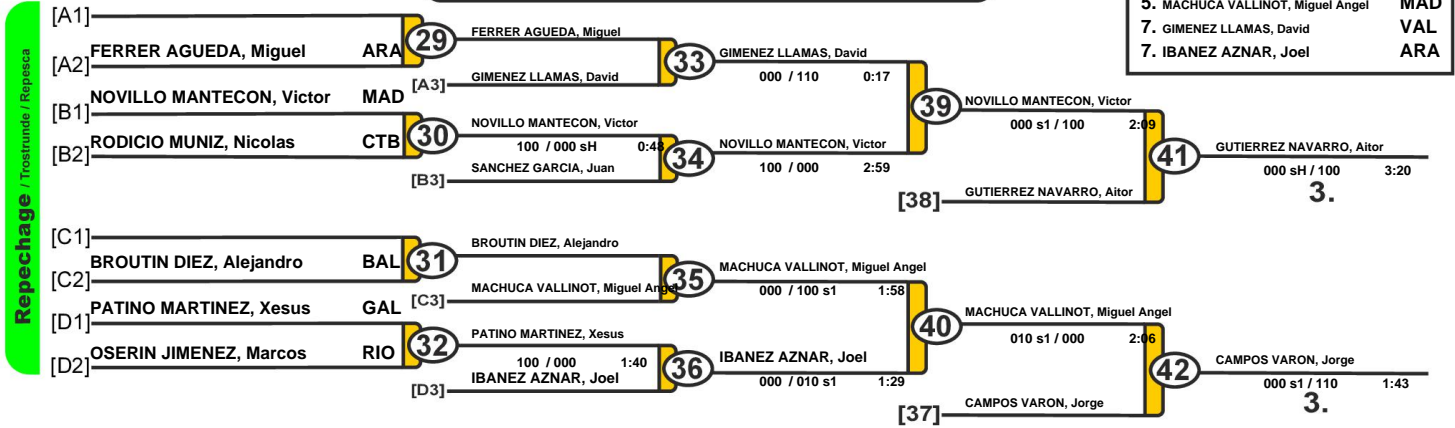

Results		
Resultat / Platzierungen / Resultados		
1.	BARROSO LOPEZ, Luis	MAD
2.	GRACIA GARIJO, Gorka	NAV
3.	GUTIERREZ NAVARRO, Aitor	MAD
5.	NOVILLO MANTECON, Victor	MAD
7.	GIMENEZ LLAMAS, David	VAL
	IBANEZ AZNAR, Joel	ARA



Campeonato de España Escolar 2017

Valencia (ESP), 06-07 May 2017

-42Inf kg

24 Judoka

POOL A

1	CABRER LLODRA, Jaume	BAL	1	CABRER LLODRA, Jaume
17			17	CABRER LLODRA, Jaume
9	RODRIGUEZ JIMENO, Mario	MAD	2	GALVEZ CORDERO, Victor
25	GALVEZ CORDERO, Victor	AND	2	GALVEZ CORDERO, Victor
5			3	ORTIZ SOLANA, Adrian
21	ORTIZ SOLANA, Adrian	CTB	3	ORTIZ SOLANA, Adrian
13	GARCIA SANTANA, Ruben	CAN	4	GARCIA SANTANA, Ruben
29	GUILLEM MARIN, Daniel	VAL	4	GARCIA SANTANA, Ruben

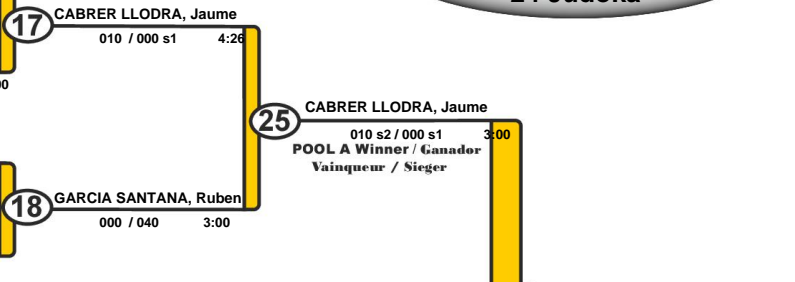

POOL B

3	ROSADO CANAS, Iker	MAD	5	ROSADO CANAS, Iker
19	GONZALEZ LOPEZ, Hugo	AST	5	ROSADO CANAS, Iker
11			6	COCINA VEIGA, Jaime
27	COCINA VEIGA, Jaime	GAL	6	COCINA VEIGA, Jaime
7	GALINDO RODRIGUEZ, Cesar	CLM	7	GUTIERREZ NAVARRO, Iker
23	GUTIERREZ NAVARRO, Iker	MAD	7	GUTIERREZ NAVARRO, Iker
15			8	OGANESYAN, Daniil
31	OGANESYAN, Daniil	CAT	8	OGANESYAN, Daniil

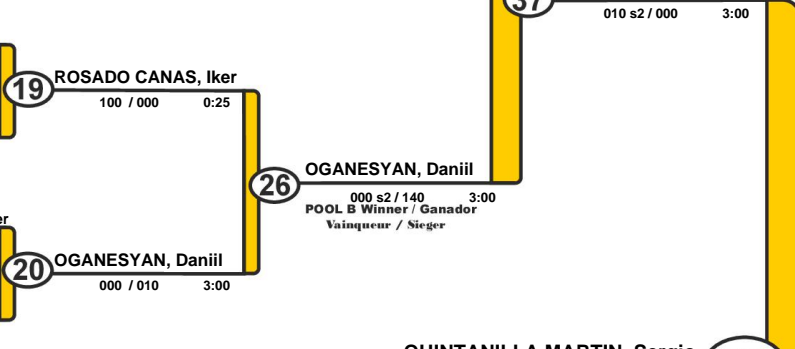

POOL C

2	QUINTANILLA MARTIN, Sergio	MAD	9	QUINTANILLA MARTIN, Sergio
18			9	QUINTANILLA MARTIN, Sergio
10	ANTON ZURDO, Alvaro	CLE	10	ANTON ZURDO, Alvaro
26	PENNEQUIN OCHOA, Gonzalo	NAV	10	ANTON ZURDO, Alvaro
6	COLINA HERNANDEZ, Igor	VAS	11	TERRON FERNANDEZ, Daniel
22	TERRON FERNANDEZ, Daniel	EXT	11	TERRON FERNANDEZ, Daniel
14			12	GONZALEZ LARRINAGA, Juan
30	GONZALEZ LARRINAGA, Juan	RIO	12	GONZALEZ LARRINAGA, Juan

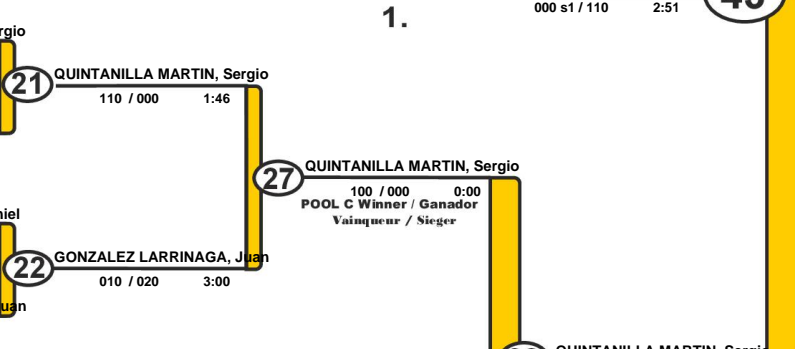

POOL D

4	CAPRANI DE DIEGO, Guillermo	VAL	13	CAPRANI DE DIEGO, Guillermo
20			13	CAPRANI DE DIEGO, Guillermo
12	GONZALEZ FELLMANN, Mikael	CAN	14	GONZALEZ FELLMANN, Mikael
28	MATEOS BOYO, Pablo	MAD	14	GONZALEZ FELLMANN, Mikael
8	MUNAR CLADERA, Juan Carlos	BAL	15	MUNAR CLADERA, Juan Carlos
24			15	MUNAR CLADERA, Juan Carlos
16	MURILLO BALDOMINOS, Daniel	ARA	16	MURILLO BALDOMINOS, Daniel
32	OTON MARIA-DOLORES, Antoni	MUR	16	MURILLO BALDOMINOS, Daniel

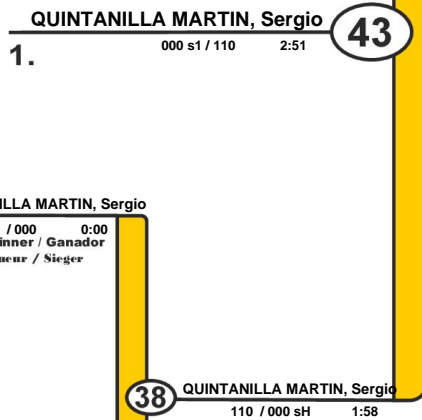
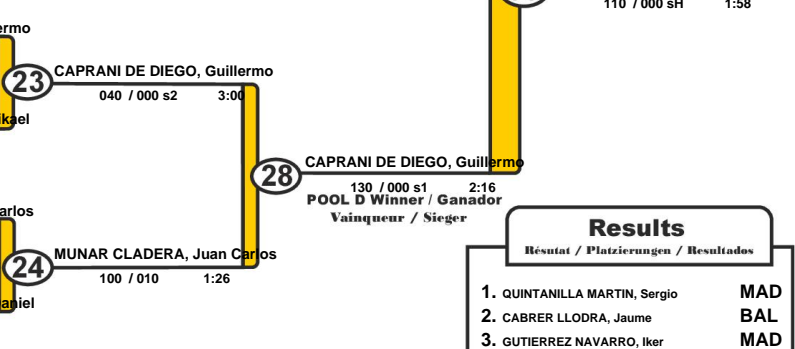

Results		
Resultat / Platzierungen / Resultados		
1.	QUINTANILLA MARTIN, Sergio	MAD
2.	CABRER LLODRA, Jaume	BAL
3.	GUTIERREZ NAVARRO, Iker	MAD
4.	GONZALEZ FELLMANN, Mikael	CAN
5.	CAPRANI DE DIEGO, Guillermo	VAL
6.	OGANESYAN, Daniil	CAT
7.	GARCIA SANTANA, Ruben	CAN
8.	ANTON ZURDO, Alvaro	CLE

Trostrunde / Repechage / Ronda de consolación

Repechage / Trostrunde / Repesca

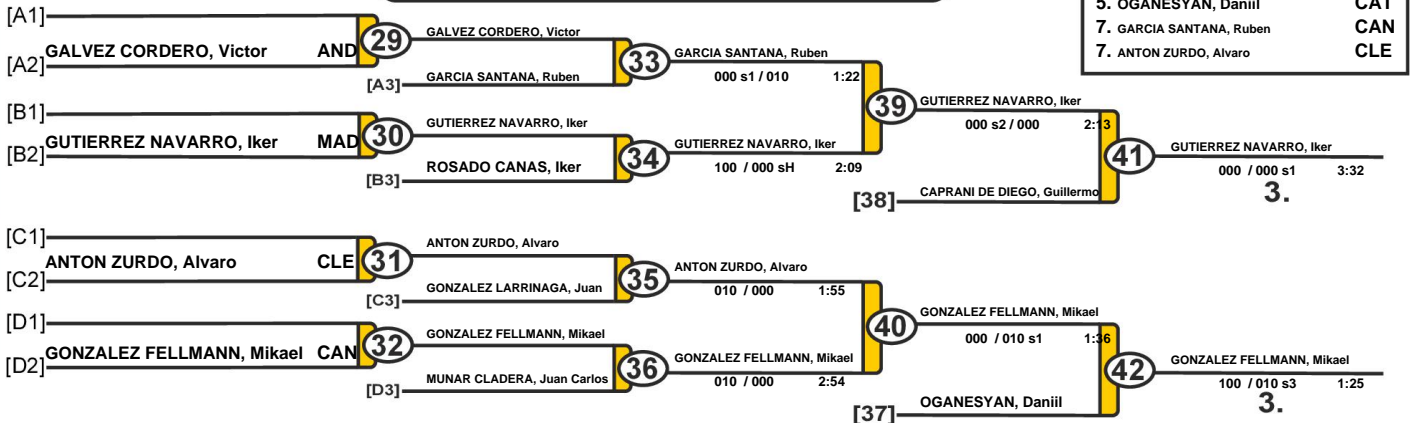



Campeonato de España Escolar 2017

Valencia (ESP), 06-07 May 2017

-46Inf kg

24 Judoka

POOL A

1	JALON GONZALEZ, Alejandro	CLE	1	JALON GONZALEZ, Alejandro	17	MIER AROCO, Roberto
17						000 / 110 2:32
9	PAVON GARCIA, Erlantz	VAS	2	MIER AROCO, Roberto	2	MIER AROCO, Roberto
25	MIER AROCO, Roberto	MAD				000 / 100 0:53
5	ARIAS SANCHEZ, Miguel	VAL	3	ARIAS SANCHEZ, Miguel	18	GARCIA SANTANA, David
21						000 s2 / 100 s1 1:53
13	LOZANO MULET, Luis	BAL	4	GARCIA SANTANA, David	25	GARCIA SANTANA, David
29	GARCIA SANTANA, David	CAN				000 s1 / 010 3:00

POOL B

3	LLAMAS LOPEZ, Francisco Javier	MUR	5	LLAMAS LOPEZ, Francisco Javier	19	PORTELA RIVEIRO, Miguel
19	CUPIDO MARTIN, Jose Manuel	EXT				020 s2 / 010 s1 3:00
11	PORTELA RIVEIRO, Miguel	GAL	6	PORTELA RIVEIRO, Miguel	26	BECHDEJU COLL, Marc
27						000 / 100 0:06
7	GOMEZ GUERRA, Javier	CLM	7	BECHDEJU COLL, Marc	20	BECHDEJU COLL, Marc
23	BECHDEJU COLL, Marc	CAT				000 / 100 s1 3:39
15			8	NEVADO MARTIN, Ivan	37	BECHDEJU COLL, Marc
31	NEVADO MARTIN, Ivan	MAD				130 / 000 s1 3:00

POOL C

2	SUAREZ ARTILES, Giovanni	CAN	9	SUAREZ ARTILES, Giovanni	21	MORALES BILBAO, Enrique
18						000 / 010 s2 3:00
10	MORALES BILBAO, Enrique	CTB	10	MORALES BILBAO, Enrique	27	MORALES BILBAO, Enrique
26	MORALES HERRERO, Miguel	AND				110 / 000 0:18
6			11	PASCUAL CARDENAS, Alvaro	22	PEREZ COLLAZO, Alberto
22	PASCUAL CARDENAS, Alvaro	MAD				000 s2 / 000 s1 4:13
14	CREMADES ALBERT, Alberto	VAL	12	PEREZ COLLAZO, Alberto	38	ADRIAN BALTOI, Carlos
30	PEREZ COLLAZO, Alberto	RIO				000 / 100 1:37

POOL D

4	ADRIAN BALTOI, Carlos	VAL	13	ADRIAN BALTOI, Carlos	23	ADRIAN BALTOI, Carlos
20						100 / 000 0:10
12	DIEZ URCAREGUI, Alejandro	CLE	14	VICENTE GARDE, Roman	28	ADRIAN BALTOI, Carlos
28	VICENTE GARDE, Roman	ARA				000 s3 / 100 s1 2:34
8	CAMACHO ALVAREZ, Oscar	AST	15	CAMACHO ALVAREZ, Oscar	24	CAMACHO ALVAREZ, Oscar
24						110 / 000 0:44
16	ROYO RUBIO, Sergio	MAD	16	DEL POZO ALVAREZ, Luis Maria	39	MIER AROCO, Roberto
32	DEL POZO ALVAREZ, Luis Maria	NAV				010 / 000 2:34

Trostrunde / Repechage / Ronda de consolación

[A1]	LOZANO MULET, Luis	BAL	29	ARIAS SANCHEZ, Miguel	33	MIER AROCO, Roberto
[A2]	ARIAS SANCHEZ, Miguel	VAL				000 / 010 2:23
[B1]	GOMEZ GUERRA, Javier	CLM	[A3]	MIER AROCO, Roberto	39	MIER AROCO, Roberto
[B2]	NEVADO MARTIN, Ivan	MAD				000 s2 / 000 2:36
			30	NEVADO MARTIN, Ivan	34	PORTELA RIVEIRO, Miguel
						000 / 100 2:51
			[B3]	PORTELA RIVEIRO, Miguel	41	MIER AROCO, Roberto
						100 / 000 s1 3:19
[C1]	MORALES HERRERO, Miguel	AND	[38]	MORALES BILBAO, Enrique	3	
[C2]	SUAREZ ARTILES, Giovanni	CAN	31	SUAREZ ARTILES, Giovanni	35	SUAREZ ARTILES, Giovanni
[C3]	PEREZ COLLAZO, Alberto					000 s1 / 010 0:52
[D1]	VICENTE GARDE, Roman	ARA	[35]	PEREZ COLLAZO, Alberto	40	SUAREZ ARTILES, Giovanni
[D2]	VICENTE GARDE, Roman					100 / 000 2:20
[D3]	CAMACHO ALVAREZ, Oscar		32	VICENTE GARDE, Roman	42	GARCIA SANTANA, David
						010 / 000 s1 0:42
			36	CAMACHO ALVAREZ, Oscar	37	GARCIA SANTANA, David
						000 s1 / 100 1:46
						000 s1 / 010 3:00

1. BECHDEJU COLL, Marc 100 / 000 0:48

2. ADRIAN BALTOI, Carlos 000 / 110 s1 2:54

3. MIER AROCO, Roberto 010 / 000 2:34

4. GARCIA SANTANA, David 000 s1 / 010 3:00

5. MORALES BILBAO, Enrique 110 / 010 1:07

6. SUAREZ ARTILES, Giovanni 000 s1 / 010 0:52

7. PORTELA RIVEIRO, Miguel 000 / 010 2:19

8. CAMACHO ALVAREZ, Oscar 110 / 000 0:44

9. SUAREZ ARTILES, Giovanni 000 s1 / 010 0:52

10. PEREZ COLLAZO, Alberto 100 / 000 2:20

11. VICENTE GARDE, Roman 010 / 000 s1 0:42

12. CAMACHO ALVAREZ, Oscar 000 s1 / 100 1:46

13. GARCIA SANTANA, David 000 s1 / 010 3:00

Results

Resultat / Platzierungen / Resultados

1. BECHDEJU COLL, Marc CAT
2. ADRIAN BALTOI, Carlos VAL
3. MIER AROCO, Roberto MAD
4. GARCIA SANTANA, David CAN
5. MORALES BILBAO, Enrique CTB
6. SUAREZ ARTILES, Giovanni CAN
7. PORTELA RIVEIRO, Miguel GAL
8. CAMACHO ALVAREZ, Oscar AST



Campeonato de España Escolar 2017

Valencia (ESP), 06-07 May 2017

-50Inf kg

26 Judoka

POOL A

1 GIMENO TRICOT, David VAL

1 GIMENO TRICOT, David

17
9 SAIZ JUAN, Hugo MAD
25 CAMPANA DEL VAL, Ruben NAV

2 SAIZ JUAN, Hugo
020 / 010 3:00

17 GIMENO TRICOT, David
050 / 000 3:00

5
21 JIMENEZ GAGO, Rafael AND

3 JIMENEZ GAGO, Rafael

25 GIMENO TRICOT, David
100 / 000 1:19
POOL A Winner / Ganador
Vainqueur / Sieger

13 CORUJEDO ZAPATERO, Iker AST
29 SCHIPPMMANN MAICAS, Alex ARA

4 SCHIPPMMANN MAICAS, Alex
000 s1 / 120 s1 2:58

18 JIMENEZ GAGO, Rafael
100 / 000 s2 2:53

POOL B

3 MARQUEZ VILLAVERDE, Javier RIO
19 HERRERO HERRERA, Alex CAT

5 MARQUEZ VILLAVERDE, Javier
020 s1 / 000 3:00

37 GIMENO TRICOT, David
110 / 000 0:22

11 VILLAR FORTEA, German MAD
27 JUAN FERNANDEZ, Diego CLE

6 VILLAR FORTEA, German
100 / 000 0:08

19 MARQUEZ VILLAVERDE, Javier
100 / 000 0:40

7
23 MARTINEZ GIMENEZ, Nicolas MUR

7 MARTINEZ GIMENEZ, Nicolas

26 MARQUEZ VILLAVERDE, Javier
020 s1 / 010 s1 3:33
POOL B Winner / Ganador
Vainqueur / Sieger

15 ROMERO QUEVEDO, Ruyman CAN
31 ALCOLEA ALARCON, Angel CLM

8 ROMERO QUEVEDO, Ruyman
100 / 000 0:07

20 ROMERO QUEVEDO, Ruyman
010 / 120 3:00

POOL C

2 MARTIN GOMEZ, Asier CLE
18

9 MARTIN GOMEZ, Asier

GIMENO TRICOT, David
1. 110 / 000 s1 1:17

43

10 LOPEZ DIAZ, Jesus AND
26 BENITEZ GIL, Roberto MAD

10 LOPEZ DIAZ, Jesus
120 / 000 0:58

21 LOPEZ DIAZ, Jesus
000 / 100 0:24

6 LOPEZ MENDEZ, Asier VAS
22 LOPEZ AGUADO, Marcos CTB

11 LOPEZ AGUADO, Marcos
000 sH / 100 0:21

27 LOPEZ DIAZ, Jesus
040 / 000 3:00
POOL C Winner / Ganador
Vainqueur / Sieger

14
30 TEBAR ESCORCIA, Pablo VAL

12 TEBAR ESCORCIA, Pablo

22 TEBAR ESCORCIA, Pablo
000 / 120 1:12

POOL D

4 RODA GOMEZ, Aaron VAL
20

13 RODA GOMEZ, Aaron

38 LOPEZ DIAZ, Jesus
100 / 000 0:21

12 ANDRINAL GRACIA, Ivan MAD
28 MATEOS BADILLO, Rodrigo EXT

14 ANDRINAL GRACIA, Ivan
100 / 010 0:59

23 ANDRINAL GRACIA, Ivan
010 / 020 s1 3:12

8 TALTALVULL MARI, Dami BAL
24 PEREZ HERNANDEZ, Diego CAN

15 TALTALVULL MARI, Dami
110 / 000 sH 2:41

28 TALTALVULL MARI, Dami
000 / 100 2:37
POOL D Winner / Ganador
Vainqueur / Sieger

16 LUCIAN HORNAR, Rudi ARA
32 ROSAL RODRIGUEZ, Bruno GAL

16 ROSAL RODRIGUEZ, Bruno
000 / 010 3:00

24 TALTALVULL MARI, Dami
030 / 010 3:00

Trostrunde / Repechage / Ronda de consolación

Repechage / Trostrunde / Repesca

[A1] SAIZ JUAN, Hugo MAD

29 SAIZ JUAN, Hugo

33 SAIZ JUAN, Hugo
010 / 000 1:13

[A2] HERRERO HERRERA, Alex CAT
[B1] VILLAR FORTEA, German MAD

[A3] JIMENEZ GAGO, Rafael
30 HERRERO HERRERA, Alex
010 / 000 2:44

34 ROMERO QUEVEDO, Ruyman
000 / 010 2:16

39 ROMERO QUEVEDO, Ruyman
000 / 010 2:21

[C1] BENITEZ GIL, Roberto MAD
[C2] MARTIN GOMEZ, Asier CLE

31 MARTIN GOMEZ, Asier
000 / 010 2:48

35 MARTIN GOMEZ, Asier
100 / 000 2:02

[D1] PEREZ HERNANDEZ, Diego CAN
[D2] ROSAL RODRIGUEZ, Bruno GAL

[C3] TEBAR ESCORCIA, Pablo
32 ROSAL RODRIGUEZ, Bruno
000 / 010 1:51

36 ROSAL RODRIGUEZ, Bruno
000 / 000 s2 2:13

40 MARTIN GOMEZ, Asier
010 / 000 1:45

37 MARQUEZ VILLAVERDE, Javier

Results	
Resultat / Platzierungen / Resultados	
1.	GIMENO TRICOT, David VAL
2.	LOPEZ DIAZ, Jesus AND
3.	TALTALVULL MARI, Dami BAL
3.	MARTIN GOMEZ, Asier CLE
5.	ROMERO QUEVEDO, Ruyman CAN
7.	MARQUEZ VILLAVERDE, Javier RIO
7.	SAIZ JUAN, Hugo MAD
7.	ROSAL RODRIGUEZ, Bruno GAL

41 TALTALVULL MARI, Dami
000 / 100 1:34
3.

42 MARTIN GOMEZ, Asier
100 / 000 s1 3:15
3.



Campeonato de España Escolar 2017

Valencia (ESP), 06-07 May 2017

-55Inf kg

24 Judoka

POOL A

1	MUCI NATALIZIO, Leonardo	VAL
17		
9	SOTELO VIEDMA, Abel	NAV
25	CASTELLO AZIROZ, Joseba	VAS

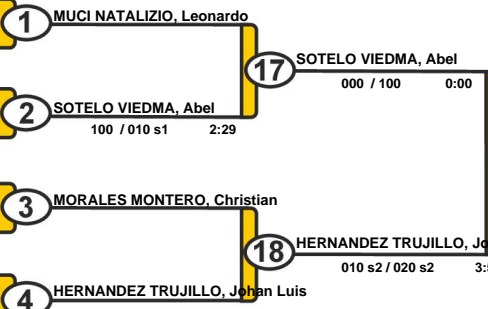

POOL B

3	CANDAL GOMEZ, Joel	GAL
19	TORRES CARBONELL, Mark	BAL
11	AGUAYO ROMAN, Alfonso	CLE
27		
7	MARTINEZ CALLEJON, Jorge	CLM
23	PEREZ AGUEDA, Rodrigo	ARA
15	SERRANO ARIAS, Victor	MAD
31	GAMIZ FERNANDEZ, Gerard	CAT

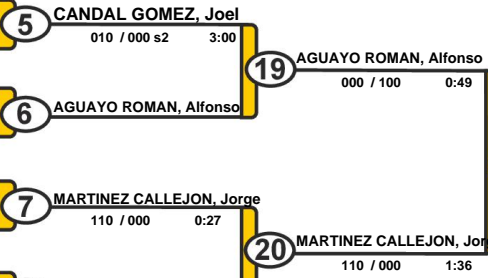

POOL C

2	SANGENIS GRAU, Pau	CAT
18		
10	PINA RODRIGUEZ, Maximo	GAL
26	PENA INSAUSTI, Juan	MAD
6	DRIS OUTMANI, Wasim	MEL
22	NUEVO CUADRADO, Pablo	MAD
14	HEREDIA FUENTES, Jose Carlos	AND
30		

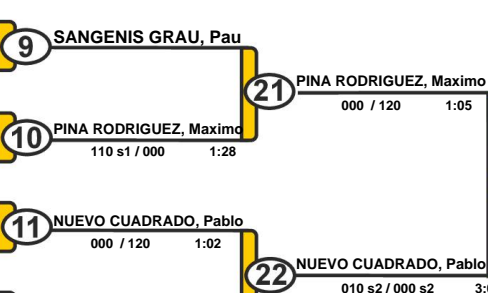

POOL D

4	ARROYO MORENO, Eduardo	MAD
20		
12	ALVAREZ MARTINEZ, Miguel	AST
28	MOLINA BANOS, Manuel	RIO
8	ANDREU JORQUERA, Jose Antonio	MJR
24		
16	GONZALEZ GARCIA, Aaron	CTB
32	GADEA JUAN, David	VAL

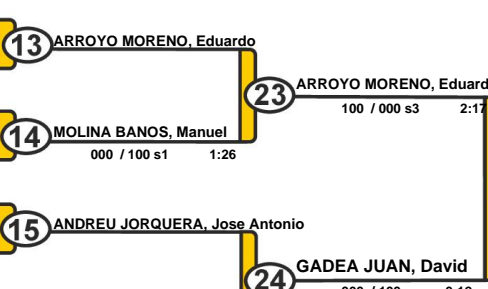

Results	
Resultat / Platzierungen / Resultados	
1.	PINA RODRIGUEZ, Maximo GAL
2.	HERNANDEZ TRUJILLO, Johan Luis CAN
3.	MARTINEZ CALLEJON, Jorge CLM
4.	AGUAYO ROMAN, Alfonso CLE
5.	GADEA JUAN, David VAL
6.	SANGENIS GRAU, Pau CAT
7.	MORALES MONTERO, Christian MAD
7.	ARROYO MORENO, Eduardo MAD

Trostrunde / Repechage / Ronda de consolación

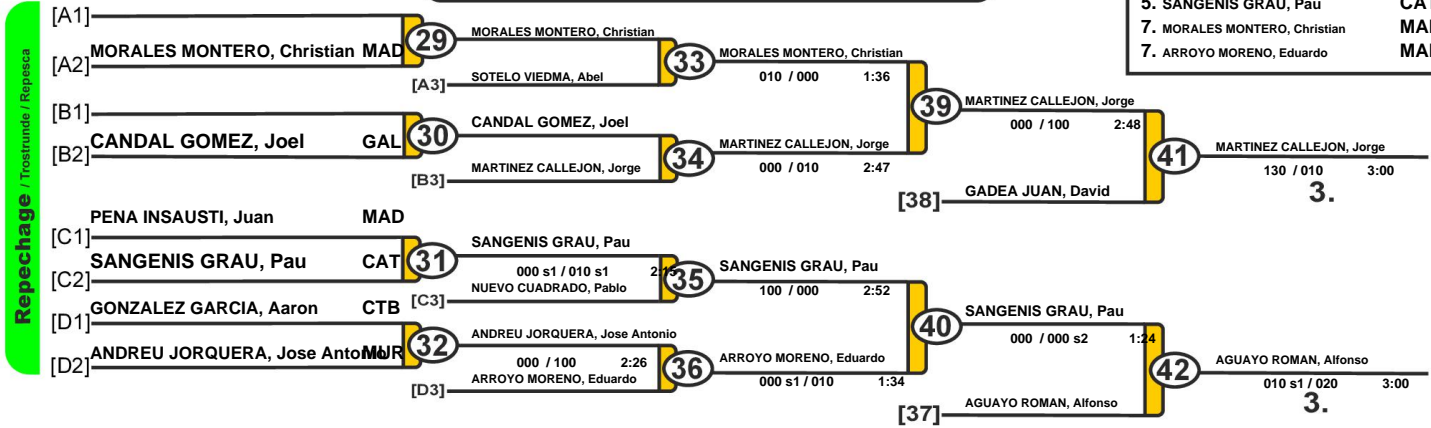



Campeonato de España Escolar 2017

Valencia (ESP), 06-07 May 2017

-60Inf kg

24 Judoka

POOL A

1	SANGIL SERRANO, Pablo	BAL	1	SANGIL SERRANO, Pablo
17			17	SANGIL SERRANO, Pablo
9	JAMARASHIVILI ABASHIDZE, Petre	PER	2	JAMARASHIVILI ABASHIDZE, Petre
25	GOMEZ MORALES, Gabriel	AND	2	010 / 000 3:00
5	RODRIGUEZ JIMENEZ, Alberto	MAD	3	RODRIGUEZ JIMENEZ, Alberto
21	BERASTEGUI ALBILLOS, Alejandro	NAV	3	110 s2 / 000 s3 2:04
13	FERNANDEZ GALLAY, Nicolas	VAL	4	MENENDEZ RUBIERA, Alfredo
29	MENENDEZ RUBIERA, Alfredo	AST	4	000 s1 / 100 2:40

POOL B

3	ESCRIVA PEREZ-CHUECO, Gabriel	BAL	5	ESCRIVA PEREZ-CHUECO, Gabriel
19	PRADILLOS RUIZ, Samuel	CLM	5	100 / 000 0:10
11	CHAVEZ MENDOZA, Alejandro	CAN	6	CHAVEZ MENDOZA, Alejandro
27			6	000 s3 / 100 s1 1:23
7	MORALES INBERMON, Adrian	VAL	7	RODRIGUEZ ROMERO, Martin
23	RODRIGUEZ ROMERO, Martin	CLE	7	000 / 100 0:12
15	SANTAMARIA RODRIGUEZ, Aaron	MAD	8	SANTAMARIA RODRIGUEZ, Aaron
31			8	020 s1 / 010 s1 3:00

POOL C

2	USELETTI CHILLARON, Oscar	BAL	9	USELETTI CHILLARON, Oscar
18			9	000 / 100 s1 2:16
10	ABEJON PEREZ, Alberto	AST	10	ABEJON PEREZ, Alberto
26			10	000 / 100 s1 2:16
6	MATEOS SANCHEZ, Gonzalo	MAD	11	MATEOS SANCHEZ, Gonzalo
22	COUTO SOLLA, Diego	GAL	11	100 / 000 0:22
14			12	MATEOS SANCHEZ, Gonzalo
30	DIAZ CABALLERO, David	CTB	12	020 / 000 s1 3:00

POOL D

4	FERNANDEZ LLORIS, Emilio	VAL	13	FERNANDEZ LLORIS, Emilio
20			13	000 / 000 s1 4:37
12	BARDERAS BLAZQUEZ, Miguel Angel	MAD	14	BARDERAS BLAZQUEZ, Miguel Angel
28	INIESTA ORTIZ, Mateo	CLM	14	110 / 000 0:47
8			15	RUIZ DE LA CUESTA FABREGAT, Eduardo
24	RUIZ DE LA CUESTA FABREGAT, Eduardo	ARA	15	000 / 100 2:37
16	GAYDOU CASTANO, Edorta	VAS	16	GAYDOU CASTANO, Edorta
32	MORENO HERNANDEZ, Angel	MUR	16	120 / 000 1:36

MATEOS SANCHEZ, Gonzalo 43
1. 010 / 110 1:13

MATEOS SANCHEZ, Gonzalo 27
POOL C Winner / Ganador
000 s1 / 010 s1 3:09
Vainqueur / Sieger

MATEOS SANCHEZ, Gonzalo 38
110 / 010 1:17

RUIZ DE LA CUESTA FABREGAT, Eduardo 28
POOL D Winner / Ganador
000 / 100 2:37
Vainqueur / Sieger

Results	
Resultat / Platzierungen / Resultados	
1.	MATEOS SANCHEZ, Gonzalo MAD
2.	SANGIL SERRANO, Pablo BAL
3.	MENENDEZ RUBIERA, Alfredo AST
3.	RODRIGUEZ ROMERO, Martin CLE
5.	RUIZ DE LA CUESTA FABREGAT, Eduardo ARA
5.	FERNANDEZ LLORIS, Emilio VAL
7.	CHAVEZ MENDOZA, Alejandro CAN
7.	ABEJON PEREZ, Alberto AST

Trostrunde / Repechage / Ronda de consolación

Repechage / Trostrunde / Repesca

[A1]	JAMARASHIVILI ABASHIDZE, Petre	29	JAMARASHIVILI ABASHIDZE, Petre	33	MENENDEZ RUBIERA, Alfredo	
[A2]					000 s1 / 010 2:09	
[B1]	MORALES INBERMON, Adrian	VAL	30	SANTAMARIA RODRIGUEZ, Aaron	34	CHAVEZ MENDOZA, Alejandro
[B2]					000 / 010 2:46	
[C1]	COUTO SOLLA, Diego	GAL	31	COUTO SOLLA, Diego	35	ABEJON PEREZ, Alberto
[C2]					100 s1 / 000 s1 2:27	
[D1]	GAYDOU CASTANO, Edorta	VAS	32	GAYDOU CASTANO, Edorta	40	FERNANDEZ LLORIS, Emilio
[D2]					000 s2 / 000 1:20	
[D3]	FERNANDEZ LLORIS, Emilio	VAL	36	FERNANDEZ LLORIS, Emilio	42	RODRIGUEZ ROMERO, Martin
					000 / 010 2:27	

RODRIGUEZ ROMERO, Martin 3. 000 / 110 1:15



Campeonato de España Escolar 2017

Valencia (ESP), 06-07 May 2017

-66Inf kg

25 Judoka

POOL A

1	LE MONZE, Antoine	CAT
17		
9	LAMSFUS CUBERO, Angel	CTB
25	CASTRILLO MORENO, Yeray	CLE
5	ROLDAN BELTRAN, Sergio	MAD
21	ZULAIKA IRIGOYEN, Aritz	NAV
13	FERNANDEZ LOPEZ, Javier	VAL
29		

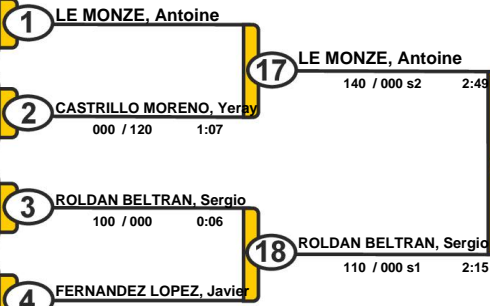

POOL B

3	MENDOZA VEGA, Diego	CAN
19	MUNIZ RODRIGUEZ, Alberto	AST
11	PARDO SERGETZ, Soni	BAL
27		
7	LAZARO MOLINA, Sergio	MAD
23	REINARES RODRIGO, Diego	RIO
15	DELGADO ALFONSO, Daniel	AND
31	VALLS MAYOR, Ermias	CAT

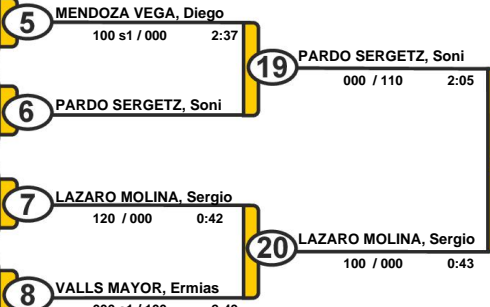

POOL C

2	KARATAYEU, Ivan	VAL
18		
10	BA, Kindi	CAT
26	FALCES RODRIGUEZ, Sergio	GAL
6	ALVAREZ MARTINEZ, Hugo	AND
22		
14	DIAZ-FLORES BASCUNANA, Ale	MAD
30	LOPEZ ROMAN, Xabat	VAS

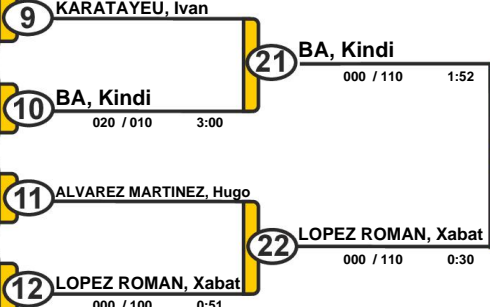

POOL D

4	RUANO HANKE, Aimede Yacoan	CAN
20		
12	MORENO CONESA, Daniel	CLM
28	BULMAGA, Liviu Basilica	ARA
8	CEJUDO CRISTOBAL, Guillermo	MAD
24	TIMCHUK, Ilyia	VAL
16		
32	FERNANDEZ GARCIA, Pedro Jose	MUR

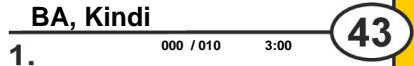
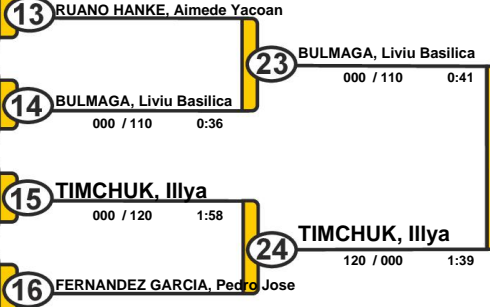

Results		
Resultat / Platzierungen / Resultados		
1.	BA, Kindi	CAT
2.	LE MONZE, Antoine	CAT
3.	TIMCHUK, Ilyia	VAL
4.	KARATAYEU, Ivan	VAL
5.	VALLS MAYOR, Ermias	CAT
6.	LAZARO MOLINA, Sergio	MAD
7.	ROLDAN BELTRAN, Sergio	MAD
8.	FERNANDEZ GARCIA, Pedro Jose	MUR

Trostrunde / Repechage / Ronda de consolación

Repechage / Trostrunde / Repechage

[A1]		
[A2]	CASTRILLO MORENO, Yeray	CLE
[B1]	REINARES RODRIGO, Diego	RIO
[B2]	VALLS MAYOR, Ermias	CAT
[C1]	FALCES RODRIGUEZ, Sergio	GAL
[C2]	KARATAYEU, Ivan	VAL
[D1]	CEJUDO CRISTOBAL, Guillermo	MAD
[D2]	FERNANDEZ GARCIA, Pedro Jose	MUR

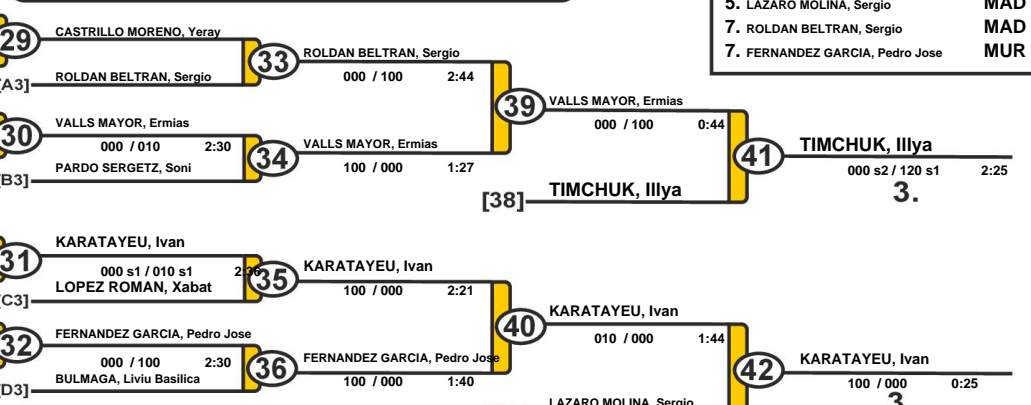



Campeonato de España Escolar 2017

Valencia (ESP), 06-07 May 2017

+66Inf kg

25 Judoka

POOL A

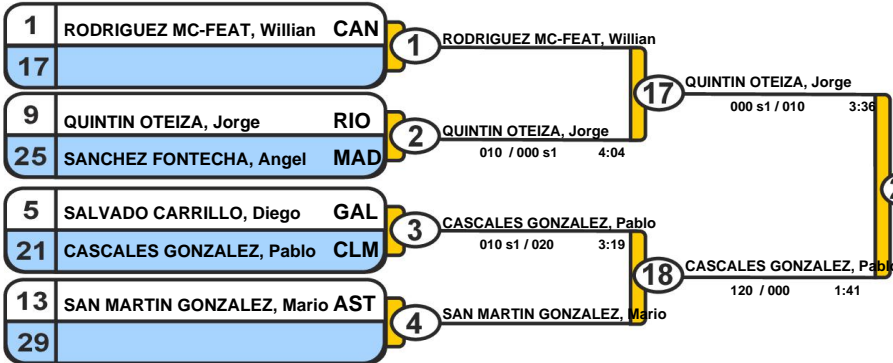

POOL B

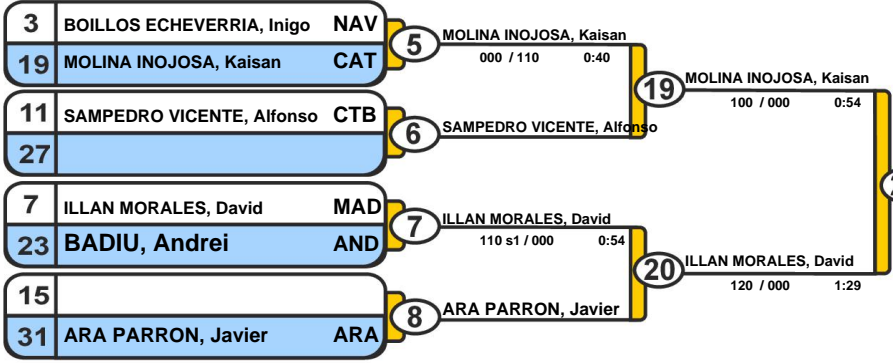

POOL C

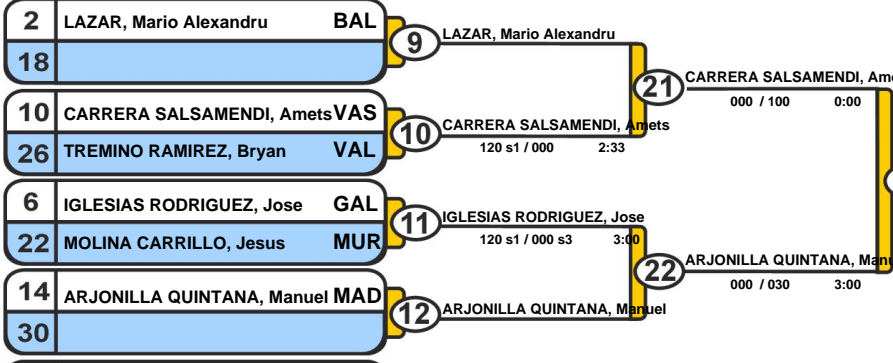

POOL D

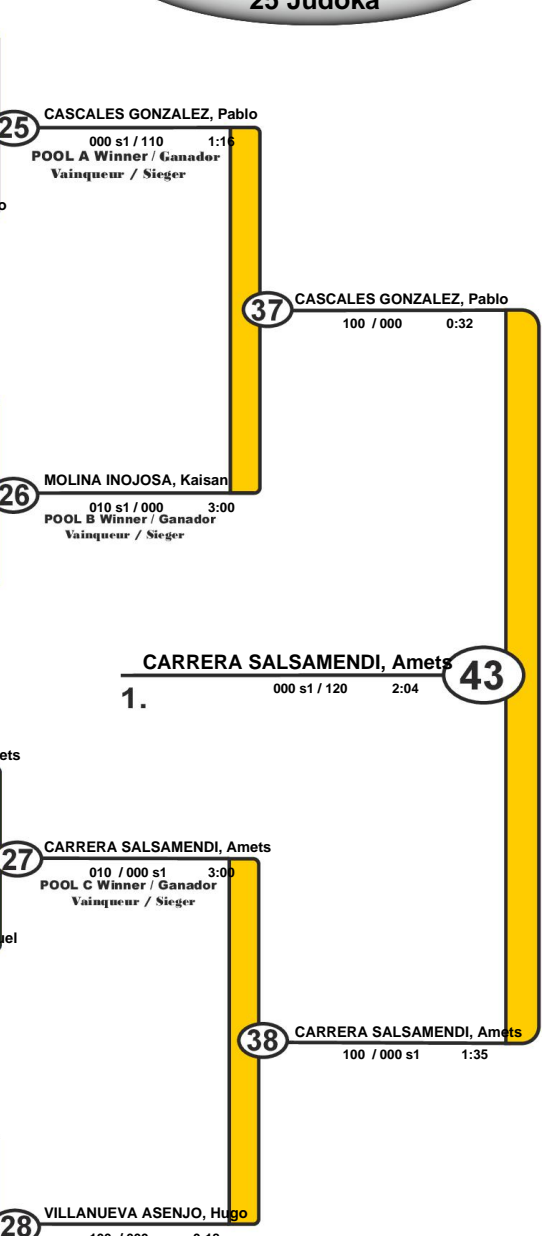
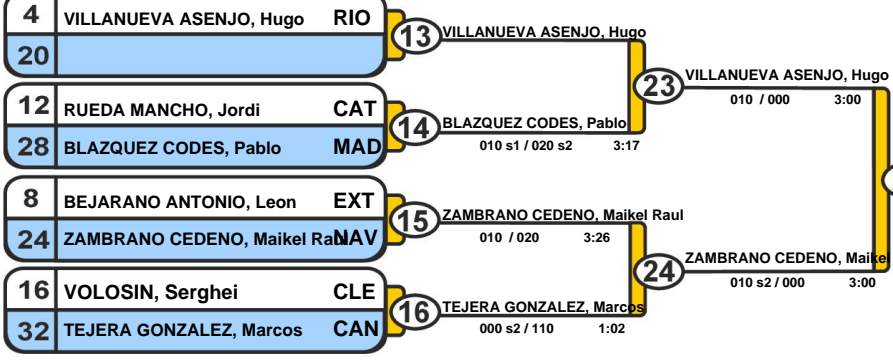

Trostrunde / Repechage / Ronda de consolación

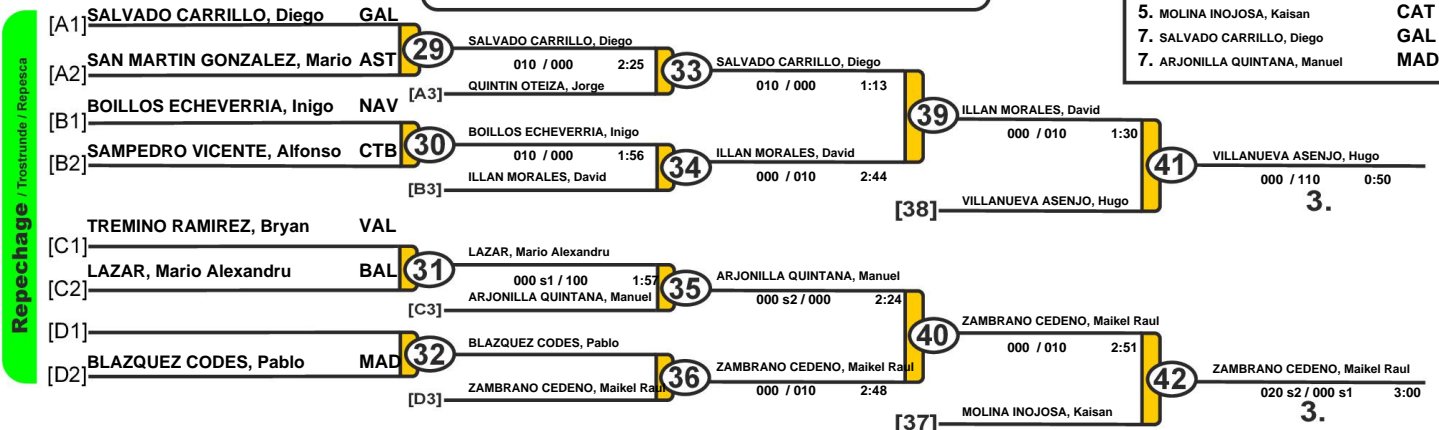

Results	
Resultat / Platzierungen / Resultados	
1.	CARRERA SALSAMENDI, Amets VAS
2.	CASCALES GONZALEZ, Pablo CLM
3.	VILLANUEVA ASENJO, Hugo RIO
3.	ZAMBRANO CEDENO, Maikel Raul NAV
5.	ILLAN MORALES, David MAD
5.	MOLINA INOJOSA, Kaisan CAT
7.	SALVADO CARRILLO, Diego GAL
7.	ARJONILLA QUINTANA, Manuel MAD



Campeonato de España Escolar 2017

Valencia (ESP), 06-07 May 2017

-46Cad kg

23 Judoka

POOL A

1	SOLA DELGADO, Ivan	NAV
17		
9	CEBRIAN SANCHEZ, Alejandro	CLM
25	SUAU MORRO, Pep	BAL
5	SANCHEZ SUAREZ, Juan	AST
21	VILLAESPESA FERNANDEZ, Alvaro	MAD
13	FERNANDEZ MOGOLLON, Iker	VAS
29		

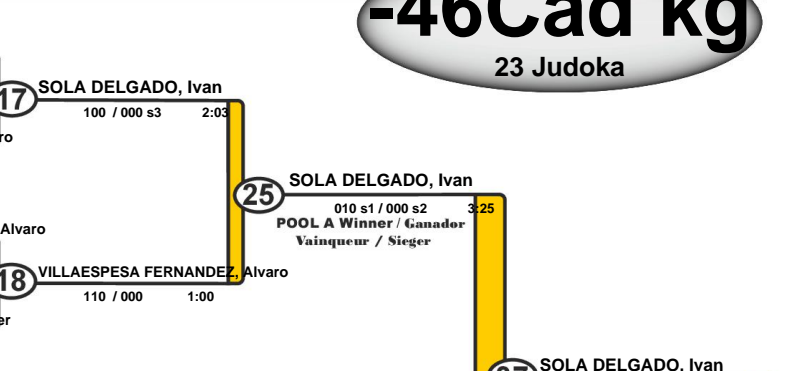

POOL B

3		
19	IZQUIERDO HERNANDEZ, Alvaro	MAD
11	PERDOMO MORENO, Josecarlos	CAN
27	GUILLAMON ANDAGUA, Daniel	MUR
7	FERRER ALMANSA, Roberto	VAL
23		
15	INOQUES MAESTRE, Alejandro	RIO
31	FLETA PALOS, Angel	ARA

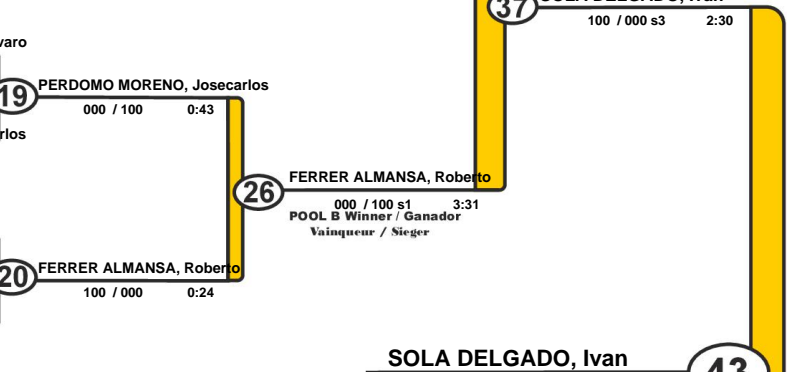

POOL C

2	VERA HENKEL, Fabio	BAL
18		
10	ZARZA COSTA, Carlos	CTB
26	DELGADO GONZALEZ, Jose Leon	CTB
6		
22	CUADROS RUIZ, Iker	VAL
14	CONTRERAS MARTIN, Oscar	CAT
30	PANIZO GUTIERREZ, Ignacio	MAD

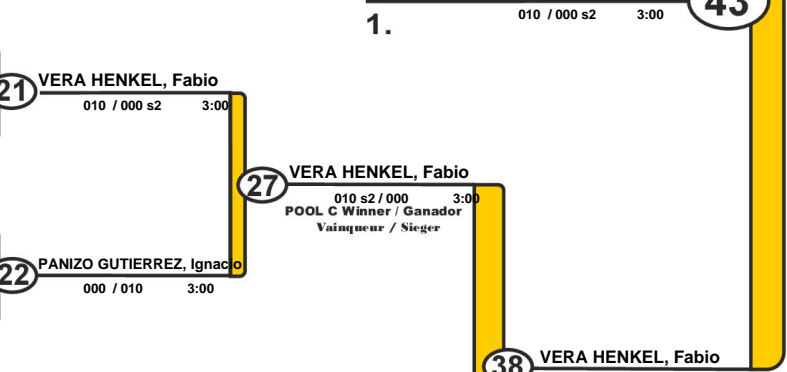

POOL D

4	IONESCU, Albano	RIO
20		
12	GAMAZO DUQUE, Manuel	MAD
28	CARBALLO ZAKARYA, Antonio	EXT
8	MURILLO MARTINEZ DE LIZARRONDO, Asier	NAV
24		
16	ORCERA CASADO, Sergio	AND
32		

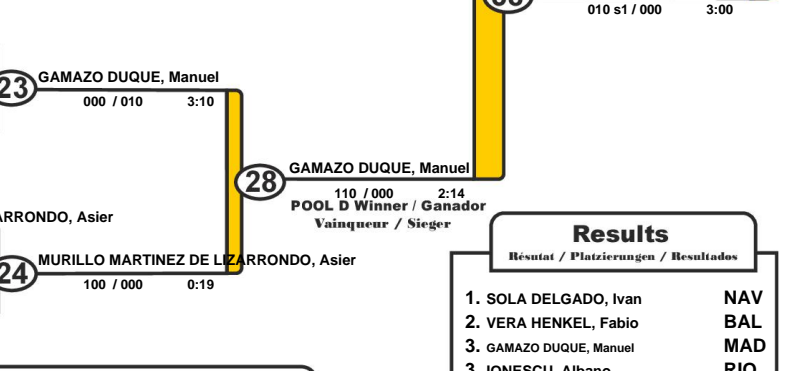

Trostrunde / Repechage / Ronda de consolación

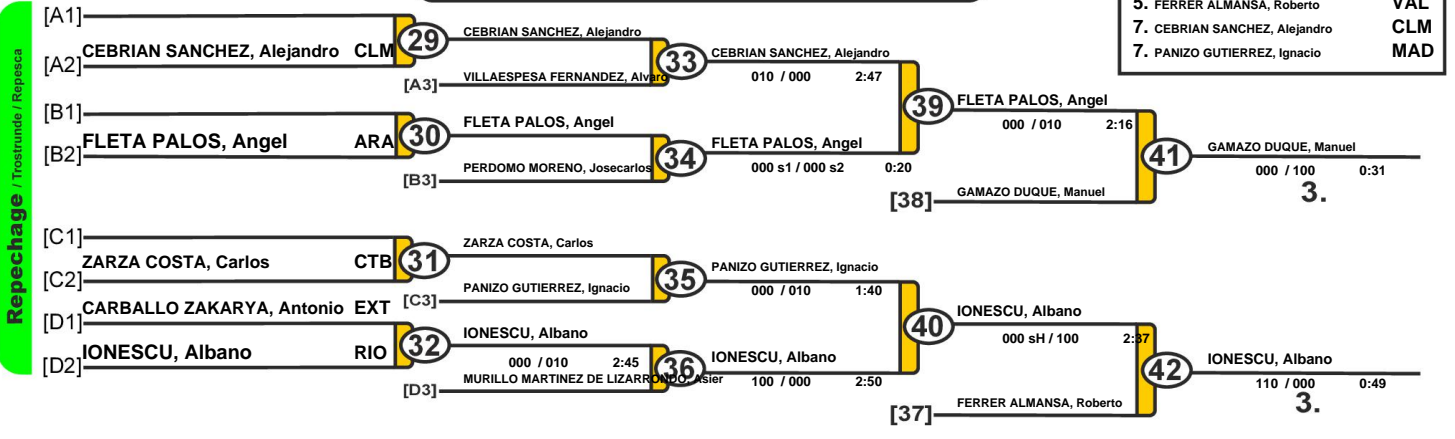

Results	
Resultat / Platzierungen / Resultados	
1.	SOLA DELGADO, Ivan NAV
2.	VERA HENKEL, Fabio BAL
3.	GAMAZO DUQUE, Manuel MAD
3.	IONESCU, Albano RIO
5.	FLETA PALOS, Angel ARA
5.	FERRER ALMANSA, Roberto VAL
7.	CEBRIAN SANCHEZ, Alejandro CLM
7.	PANIZO GUTIERREZ, Ignacio MAD



Campeonato de España Escolar 2017

Valencia (ESP), 06-07 May 2017

-50Cad kg

26 Judoka

POOL A

1	GOMEZ LLORENS, Pedro	VAL
17		
9	UZAL BUSTOS, Martin	GAL
25	ROSAS SOLANO, Alejandro	ARA
5	LOPEZ ONTIVEROS, Eduardo	MAD
21	OBREGON MUNOZ, Felix David	RIO
13	MOHAMED SADIK, Nabil	MEL
29	GARRIDO ROSA, Derek	CAT

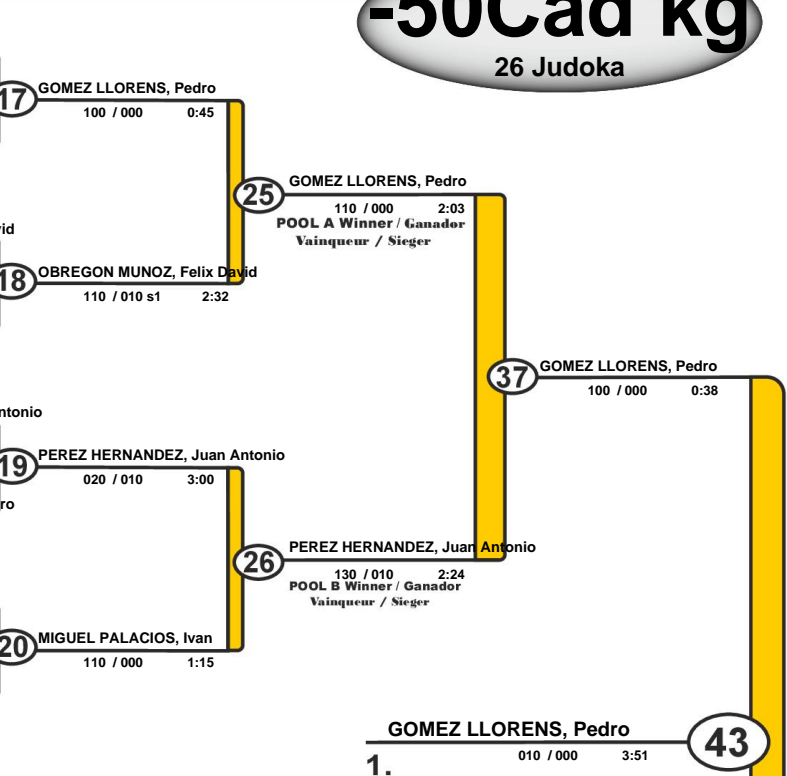

POOL B

3	CUTILLAS HERNANDEZ, Alvaro	CAN
19	PEREZ HERNANDEZ, Juan Antonio	AND
11		
27	CARRILERO VILLODRE, Alvaro	CLM
7	NAVARRO SANCHEZ, Jorge	VAL
23	MIGUEL PALACIOS, Ivan	MAD
15		
31	LLULL RIERA, Lluís	BAL

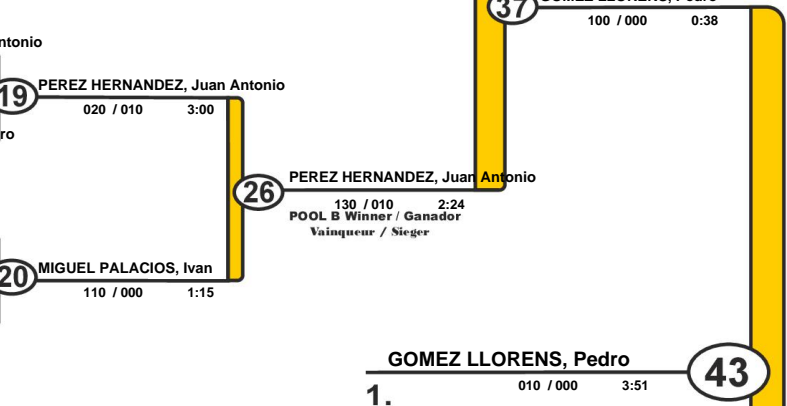

POOL C

2	BERNABEU RICO, Jaume	VAL
18		
10	LEON ALEGRIA, Yurian	NAV
26	TABUENCA LINDE, Diego	MAD
6	PINA TEROL, Sergio	MUR
22	SAN JOSE BARANDA, Daniel	CTB
14	BERMEJO BASURDE, Unai	VAS
30		

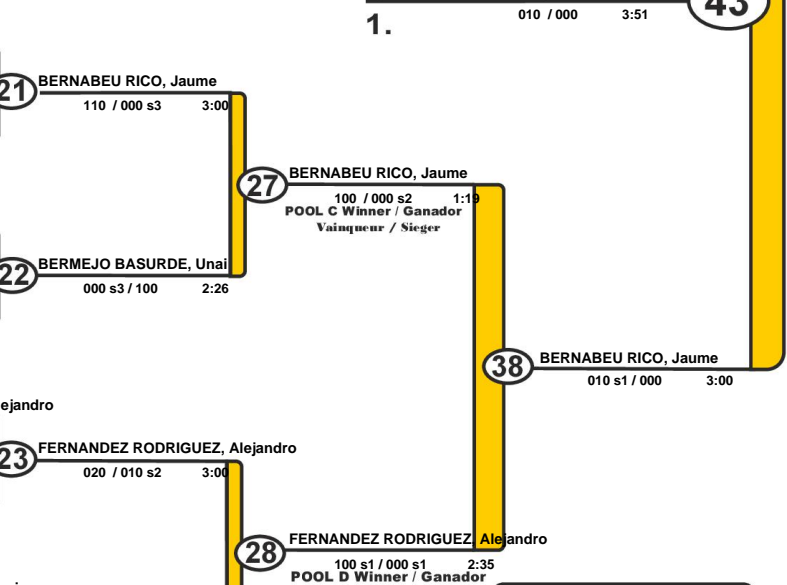

POOL D

4	FERNANDEZ RODRIGUEZ, Alejandro	MAD
20		
12	SENENT SORIANO, Luis	VAL
28	ESCANDELL TORRES, Andreu	BAL
8	KOLSTER BORGES, Arturo Javier	MAD
24	MARTINEZ GONZALEZ, Miguel Angel	CEA
16	FERNANDEZ ARTIME, Pablo	AST
32	GARCIA VALLE, Jaime	EXT



Trostrunde / Repechage / Ronda de consolación

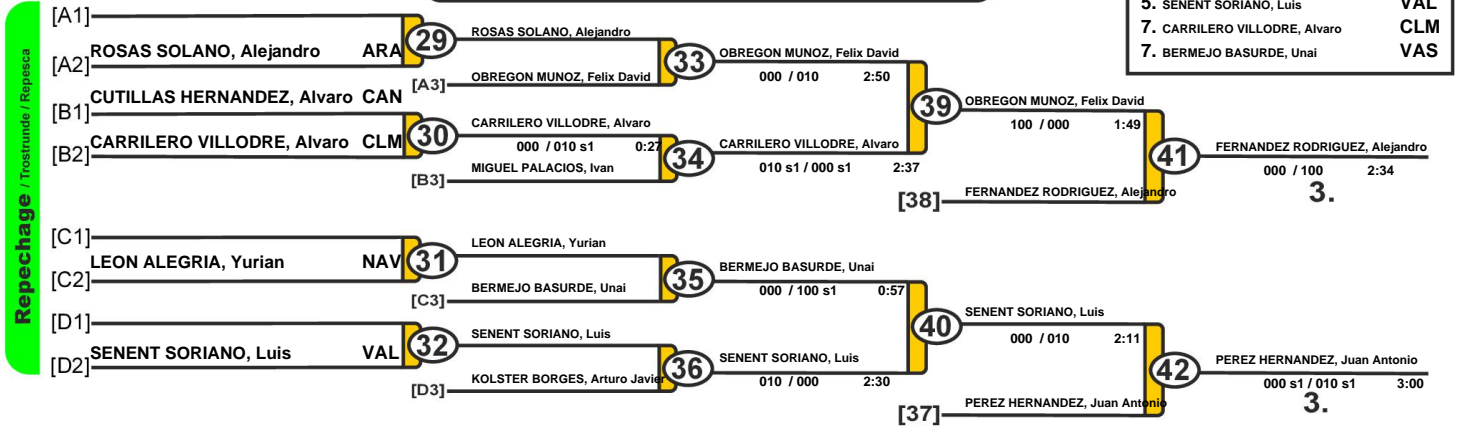

Results	
Resultat / Platzierungen / Resultados	
1.	GOMEZ LLORENS, Pedro VAL
2.	BERNABEU RICO, Jaume VAL
3.	FERNANDEZ RODRIGUEZ, Alejandro MAD
4.	PEREZ HERNANDEZ, Juan Antonio AND
5.	OBREGON MUNOZ, Felix David RIO
6.	SENENT SORIANO, Luis VAL
7.	CARRILERO VILLODRE, Alvaro CLM
8.	BERMEJO BASURDE, Unai VAS



Campeonato de España Escolar 2017

Valencia (ESP), 06-07 May 2017

-55Cad kg

24 Judoka

POOL A

1	FERNANDEZ TENREIRO, Alejandro	GAL
17		
9	CABEZUDO NIETO, Mario	CLE
25	FUENTES TALAVERA, Mario	CLM
5		
21	MARTINEZ SAENZ, Mario	EXT
13	AZNAL SANTAREN, Alexis	MAD
29	CORTABITARTE ZUBIAGA, Alex	VAS

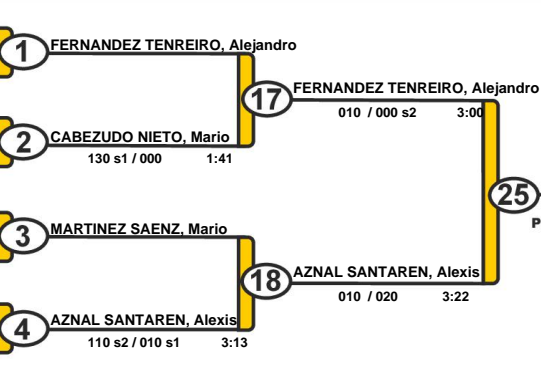

POOL A Winner / Ganador
Vainqueur / Sieger

POOL B

3	SOTO RODRIGUEZ, Antuan	RIO
19	GALLEGO SAEZ, Daniel	MAD
11		
27	CORRAL GARRIDO, Javier	AST
7	LOZANO MERINO, Ruben	CTB
23	FERRER CASTILLO, Diego	ARA
15		
31	PALACIOS CALZADO, Sergio	NAV

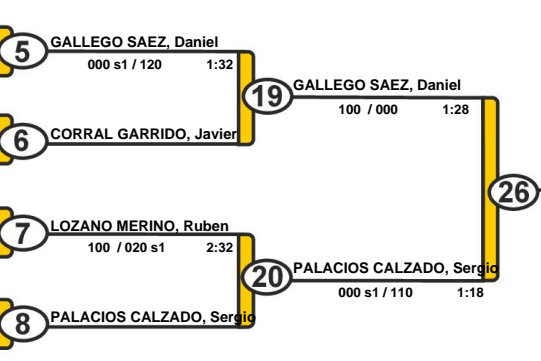

POOL B Winner / Ganador
Vainqueur / Sieger

POOL C

2	TORO SOLER, Julen	NAV
18		
10	PEREZ ROLDAN, Javier	AND
26	SIERRA SOLER, Mario	MUR
6		
22	DRIS OUTMANI, Abdelhatic	MEL
14	PORRAS FERREIRO, Gaizka	VAL
30	SANCHEZ VELASCO, Gorka	MAD

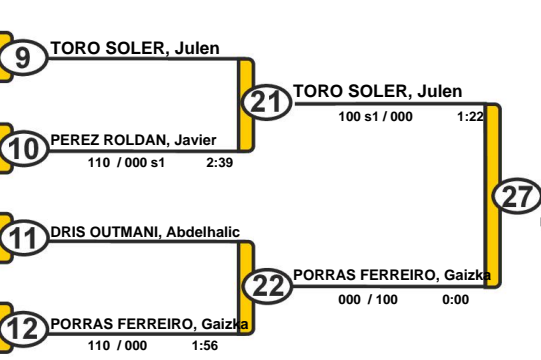

POOL C Winner / Ganador
Vainqueur / Sieger

POOL D

4	ALVAREZ CEMENLIN, David	GAL
20	LLOPE GARCIA, Iyan	AST
12	ARQUELLA LEON, Joan Antoni	BAL
28		
8		
24	RODRIGUEZ RODRIGUEZ, Javier	CAN
16	BARROSO LOPEZ, Alejandro	MAD
32	SANTACREU GARCIA, Pau	CAT

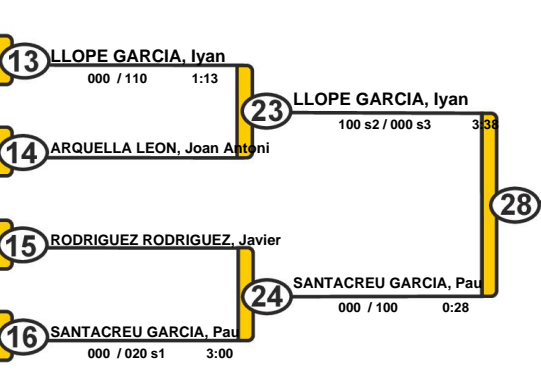

POOL D Winner / Ganador
Vainqueur / Sieger

1. FERNANDEZ TENREIRO, Alejandro
020 s1 / 000 3:00

38. TORO SOLER, Julen
020 s2 / 000 3:00

Results	
Résultat / Platzierungen / Resultados	
1.	FERNANDEZ TENREIRO, Alejandro GAL
2.	TORO SOLER, Julen NAV
3.	PALACIOS CALZADO, Sergio NAV
4.	GALLEGO SAEZ, Daniel MAD
5.	SANTACREU GARCIA, Pau CAT
6.	PORRAS FERREIRO, Gaizka VAL
7.	AZNAL SANTAREN, Alexis MAD
8.	LLOPE GARCIA, Iyan AST

Trostrunde / Repechage / Ronda de consolação

Repechage / Trostrunde / Repesca

[A1]		
[A2]	CABEZUDO NIETO, Mario	CLE
[B1]	SOTO RODRIGUEZ, Antuan	RIO
[B2]	CORRAL GARRIDO, Javier	AST
[C1]	PEREZ ROLDAN, Javier	AND
[C2]	BARROSO LOPEZ, Alejandro	MAD
[D1]	RODRIGUEZ RODRIGUEZ, Javier	CAN
[D2]		

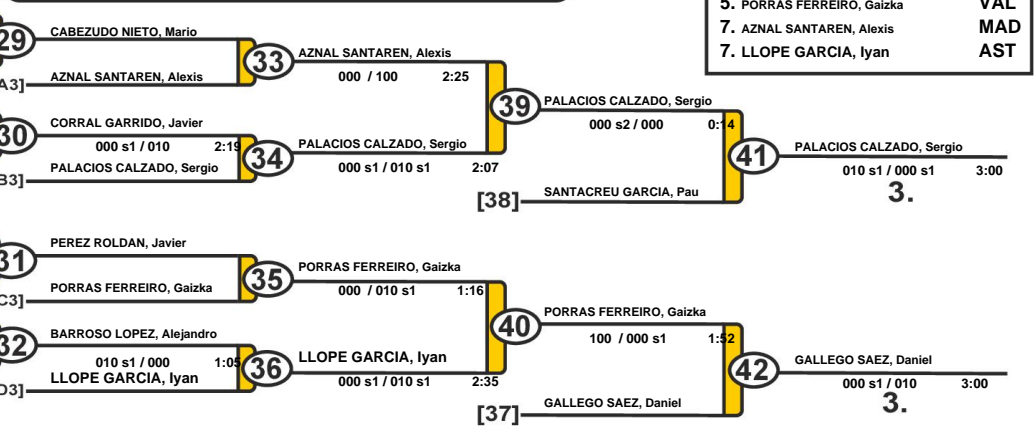



Campeonato de España Escolar 2017

Valencia (ESP), 06-07 May 2017

-60Cad kg

26 Judoka

POOL A

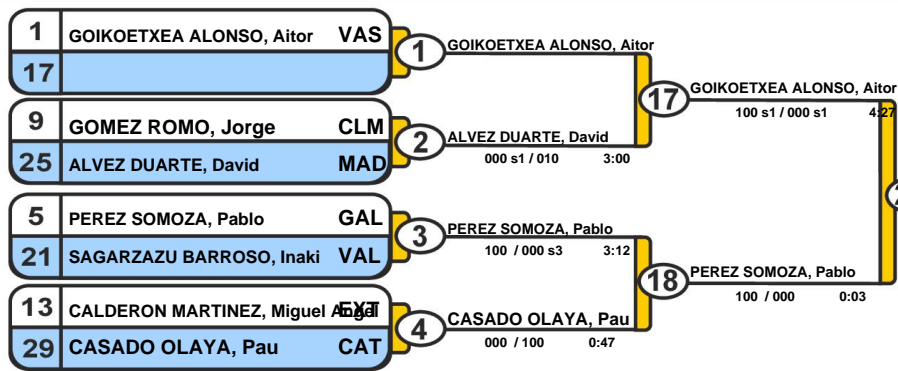

POOL B

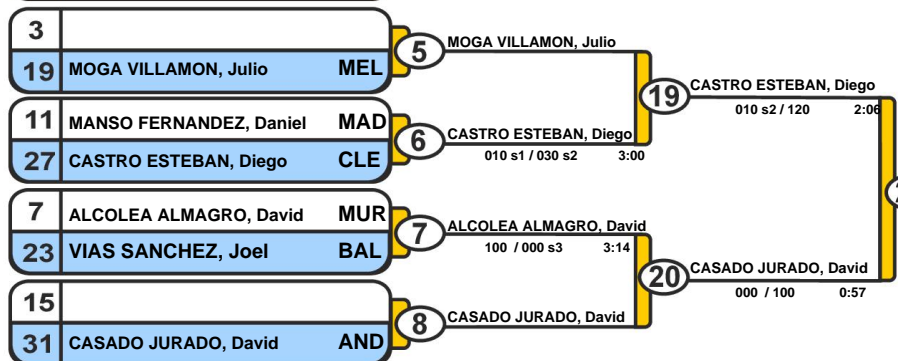

POOL C

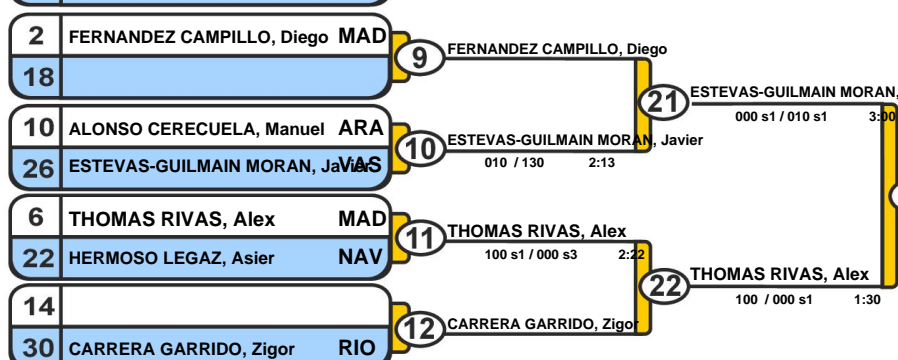

POOL D

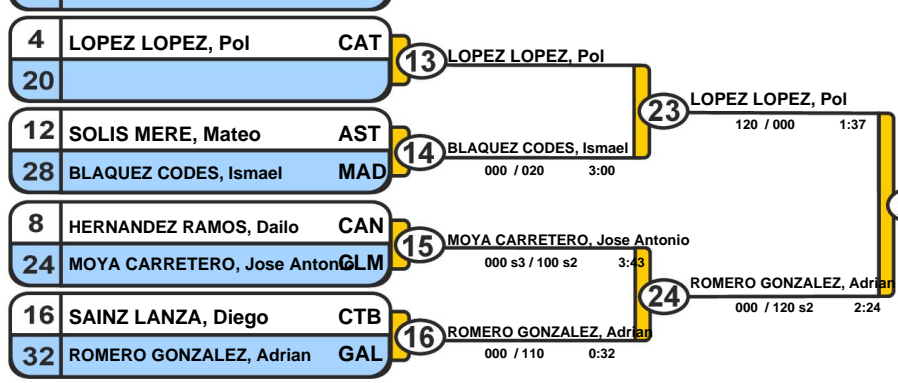

LOPEZ LOPEZ, Pol (43) 1. 000 s2 / 010 s2 4:28

Results	
Résultat / Platzierungen / Resultados	
1.	LOPEZ LOPEZ, Pol CAT
2.	GOIKOETXEA ALONSO, Aitor VAS
3.	ESTEVAS-GUILMAIN MORAN, Javier VAS
3.	FERNANDEZ CAMPILLO, Diego MAD
5.	ALVEZ DUARTE, David MAD
5.	CASADO JURADO, David AND
7.	CASTRO ESTEBAN, Diego CLE
7.	ROMERO GONZALEZ, Adrian GAL

Trostrunde / Repechage / Ronda de consolação

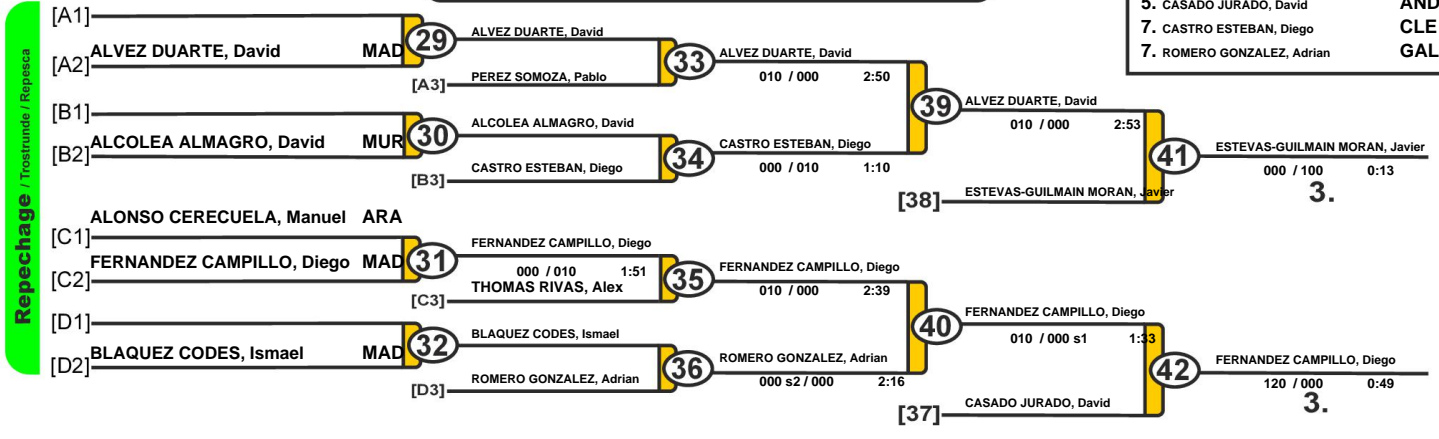



Campeonato de España Escolar 2017

Valencia (ESP), 06-07 May 2017

-66Cad kg

29 Judoka

POOL A

1	PENA INSAUSTI, Javier	MAD	1	PENA INSAUSTI, Javier
17			17	PENA INSAUSTI, Javier
9	CALLEJAS SANCHEZ, Juan Jose	AND	2	CALLEJAS SANCHEZ, Juan Jose
25	NUNO ARTIME, Pablo	AST	25	PENA INSAUSTI, Javier
5	ESTEVE MARIN, Jose Miguel	MUR	3	ESTEVE MARIN, Jose Miguel
21	MARTIN PINEDA, Alejandro	CLM	18	SENEN SORIAMO, Adrian
13	SENEN SORIAMO, Adrian	VAL	4	SENEN SORIAMO, Adrian
29	PEREZ FERREIRO, Pablo Miguel	GAL		

POOL B

3	PAZOS PLANELLS, Sergio	BAL	5	PAZOS PLANELLS, Sergio
19	CARDONA ORTIZ, Alejandro	RIO	19	PAZOS PLANELLS, Sergio
11	GIL AUGUSTO, Miguel	MAD	6	GONZALEZ FUENTES, Jose Luis
27	GONZALEZ FUENTES, Jose Luis	MEL	26	MANGAS ROMO, Marcos
7	BASTIDA DIEZ DE ULZURRUN, Oihane	NAV	7	BERNAL ZUBIMENDI, Martxel
23	BERNAL ZUBIMENDI, Martxel	VAS	20	MANGAS ROMO, Marcos
15	ARJONA HAMMERSLEY, Liam	CAT	8	MANGAS ROMO, Marcos
31	MANGAS ROMO, Marcos	CLE		

POOL C

2	GARCIA SANRAFAEL, Marc	CAT	9	GARCIA SANRAFAEL, Marc
18			21	GARCIA SANRAFAEL, Marc
10	ROMERO SANCHEZ, Adrian	EXT	10	ROMERO SANCHEZ, Adrian
26	CALVO ARGOS, Jaime	CTB	27	GARCIA SANRAFAEL, Marc
6	HIDALGO GOMEZ, Pelayo	MAD	11	HIDALGO GOMEZ, Pelayo
22	CORDOBA GALLEG0, Francisco	VAL	22	GARCIA OBENSA, Sergio
14	GARCIA OBENSA, Sergio	ARA	12	GARCIA OBENSA, Sergio
30	MERINO MENCIA, Unai	VAS		

POOL D

4	AGRELO FERNANDEZ, Alberto	AST	13	AGRELO FERNANDEZ, Alberto
20			23	GIRON HASHINO, Ian
12	GIRON HASHINO, Ian	MAD	14	GIRON HASHINO, Ian
28	RODRIGUEZ CASTELLANO, Gerard	CAN	15	MORALES PUCHE, Ernesto
8	RUEDA TAGLE, Javier	MAD	16	CORCHERO RUIZ, Iker
24	MORALES PUCHE, Ernesto	AND	24	MORALES PUCHE, Ernesto
16	CORCHERO RUIZ, Iker	CAT		
32	*GALARRAGA CASTELLO, Jokin	VAS		

Trostrunde / Repechage / Ronda de consolación

[A1]		29	CALLEJAS SANCHEZ, Juan Jose	33	CALLEJAS SANCHEZ, Juan Jose		
[A2]	CALLEJAS SANCHEZ, Juan Jose	AND					
[B1]	ARJONA HAMMERSLEY, Liam	CAT	[A3]	SENEN SORIAMO, Adrian	33	CALLEJAS SANCHEZ, Juan Jose	
[B2]	BERNAL ZUBIMENDI, Martxel	VAS	30	BERNAL ZUBIMENDI, Martxel	39	CALLEJAS SANCHEZ, Juan Jose	
[B3]	PAZOS PLANELLS, Sergio		34	BERNAL ZUBIMENDI, Martxel	41	GARCIA SANRAFAEL, Marc	
[C1]	ROMERO SANCHEZ, Adrian	EXT	31	ROMERO SANCHEZ, Adrian	[38]	GARCIA SANRAFAEL, Marc	
[C2]	RUEDA TAGLE, Javier	MAD	[C3]	GARCIA OBENSA, Sergio	35	GARCIA OBENSA, Sergio	
[D1]	CORCHERO RUIZ, Iker	CAT	32	RUEDA TAGLE, Javier	40	GARCIA OBENSA, Sergio	
[D2]	GIRON HASHINO, Ian		[D3]	GIRON HASHINO, Ian	36	RUEDA TAGLE, Javier	
					[37]	MANGAS ROMO, Marcos	
						42	GARCIA OBENSA, Sergio

1. PENA INSAUSTI, Javier
100 / 000 0:52

2. GARCIA SANRAFAEL, Marc
010 / 000 3:00
POOL C Winner / Ganador
Vainqueur / Sieger

3. MORALES PUCHE, Ernesto
000 / 010 3:00
POOL D Winner / Ganador
Vainqueur / Sieger

Results		
Résultat / Platzierungen / Resultados		
1.	PENA INSAUSTI, Javier	MAD
2.	MORALES PUCHE, Ernesto	AND
3.	GARCIA SANRAFAEL, Marc	CAT
4.	GARCIA OBENSA, Sergio	ARA
5.	CALLEJAS SANCHEZ, Juan Jose	AND
6.	MANGAS ROMO, Marcos	CLE
7.	BERNAL ZUBIMENDI, Martxel	VAS
8.	RUEDA TAGLE, Javier	MAD



Campeonato de España Escolar 2017

Valencia (ESP), 06-07 May 2017

-73Cad kg

24 Judoka

POOL A

1	NIETO TRINIDAD, Daniel	EXT	1	NIETO TRINIDAD, Daniel
17			17	NIETO TRINIDAD, Daniel
9	SANCHIS LAHIGUERA, Pablo	VAL	2	SANCHIS LAHIGUERA, Pablo
25	DE LA VIRGEN MONTES, Daniel	AND	2	100 / 000 0:35
5	LOPEZ ALMON, Ion	GAL	3	XARGAY ANGLADA, Artur
21	XARGAY ANGLADA, Artur	CAT	3	000 / 110 2:23
13	MARTINEZ COIN, Juan Antonio	MAD	4	MARTINEZ COIN, Juan Antonio
29			4	

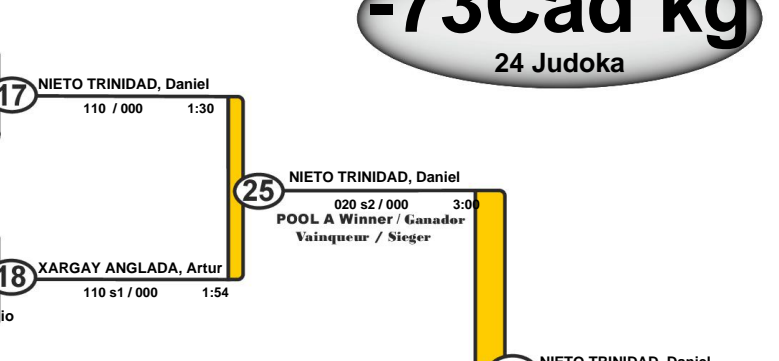

POOL B

3	PEREZ CARRERAS, Javier	ARA	5	ROMERO LOPEZ, Guillermo
19	ROMERO LOPEZ, Guillermo	MUR	5	010 s3 / 100 2:35
11			6	ALDAZ AGORRETA, Ruben
27	ALDAZ AGORRETA, Ruben	NAV	6	
7			7	MORALES MESA, Yone
23	MORALES MESA, Yone	CAN	7	
15	CHAMIZO CANO, Carlos	MAD	8	CHAMIZO CANO, Carlos
31	DIAZ GUERRA, Fernando	CTB	8	100 / 000 0:33

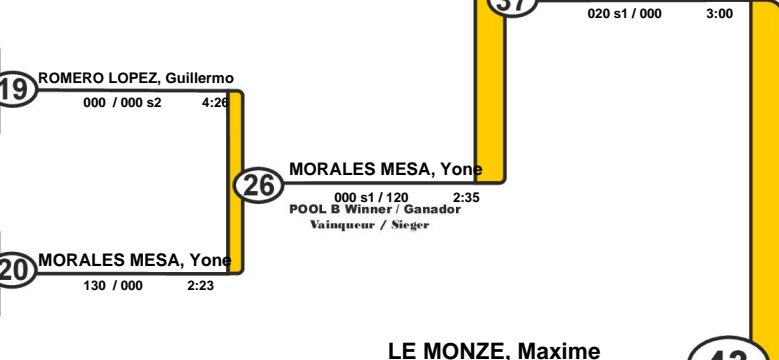

POOL C

2	NIAURI, Omari	VAL	9	NIAURI, Omari
18			9	
10	GARCIA PEREZ, Jorge	ARA	10	GARCIA PEREZ, Jorge
26	ALONSO MORO, Gonzalo	CLE	10	100 / 000 0:56
6	AKIMIDZE, Giorgi	RIO	11	AKIMIDZE, Giorgi
22	VAZQUEZ HUERTAS, Alejandro	EXT	11	100 s1 / 000 s3 4:21
14			12	FERNANDEZ RODRIGUEZ, Fernando
30	FERNANDEZ RODRIGUEZ, Fernando	MAD	12	

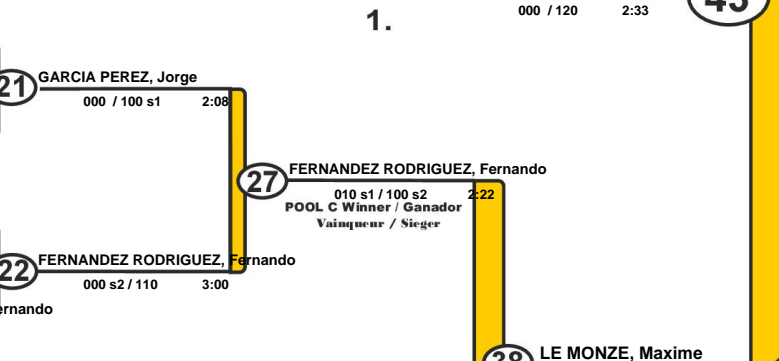

POOL D

4	LE MONZE, Maxime	CAT	13	LE MONZE, Maxime
20			13	
12	CEBRIAN GUIRAO, Julio	CLM	14	BLANCO BUGALLO, David
28	BLANCO BUGALLO, David	AST	14	000 s1 / 030 3:00
8			15	CASTILLO MENDEZ, Juan Miguel
24	CASTILLO MENDEZ, Juan Miguel	NAV	15	
16	CLAVERAS RETANA, Julian	VAS	16	CLAVERAS RETANA, Julian
32	SANCHEZ GONZALEZ, Pablo	MAD	16	140 / 010 s1 3:00

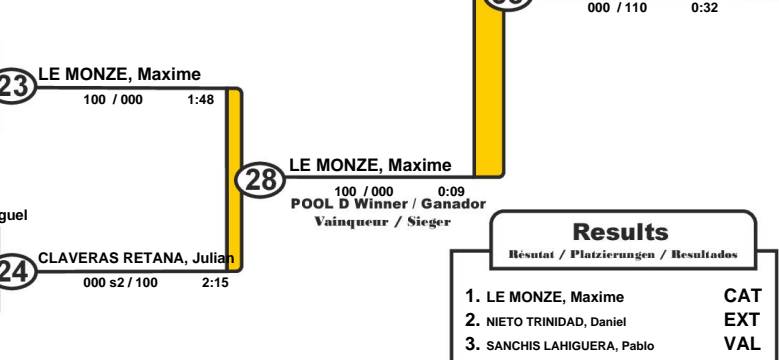

Trostrunde / Repechage / Ronda de consolación

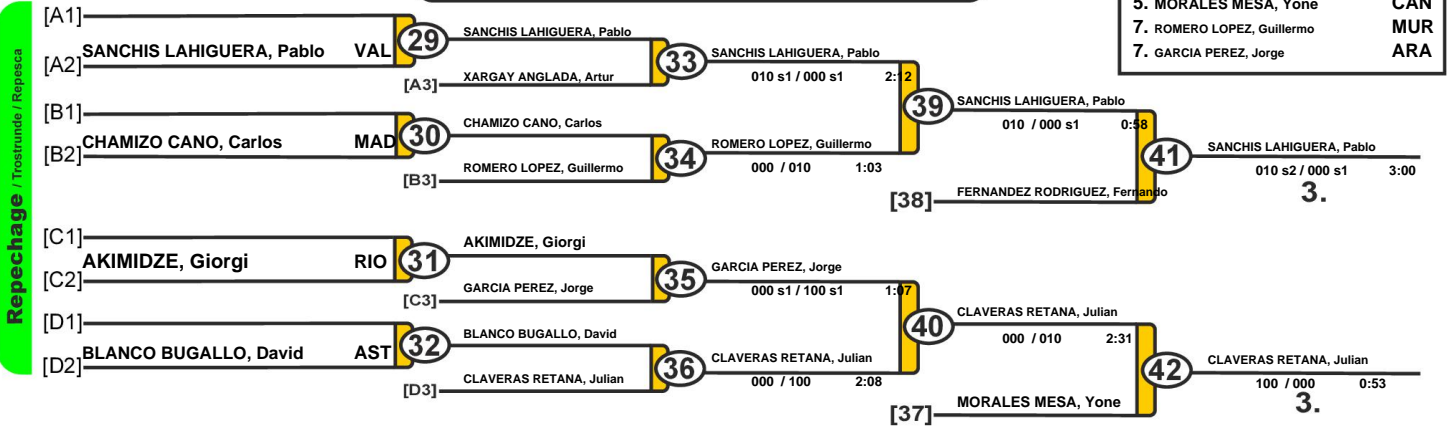

Results	
Résultat / Platzierungen / Resultados	
1.	LE MONZE, Maxime CAT
2.	NIETO TRINIDAD, Daniel EXT
3.	SANCHIS LAHIGUERA, Pablo VAL
3.	CLAVERAS RETANA, Julian VAS
5.	FERNANDEZ RODRIGUEZ, Fernando MAD
5.	MORALES MESA, Yone CAN
7.	ROMERO LOPEZ, Guillermo MUR
7.	GARCIA PEREZ, Jorge ARA



Campeonato de España Escolar 2017

Valencia (ESP), 06-07 May 2017

-81 Cad kg

24 Judoka

POOL A

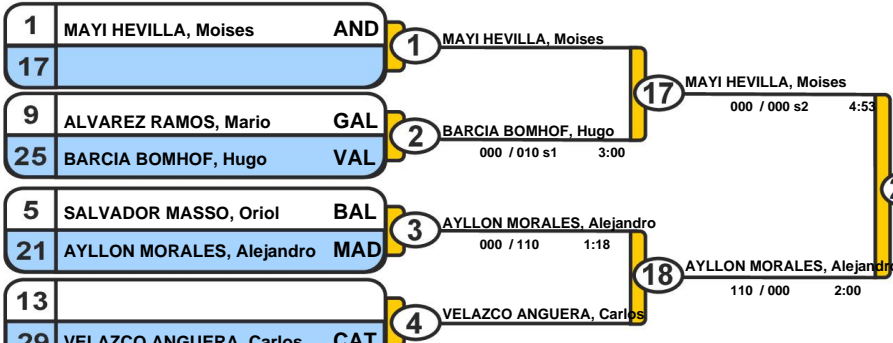

POOL B

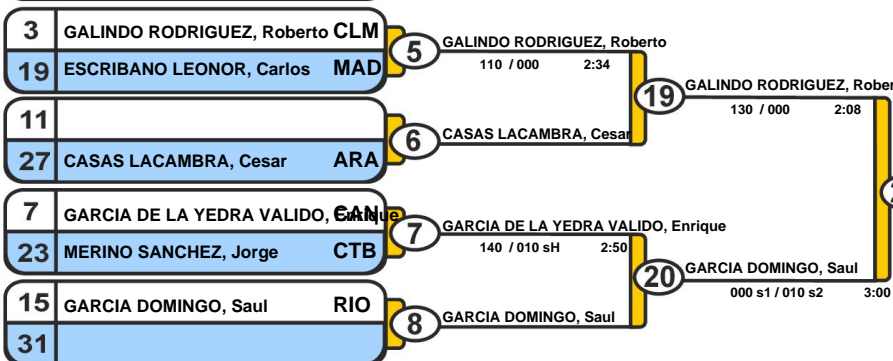

POOL C

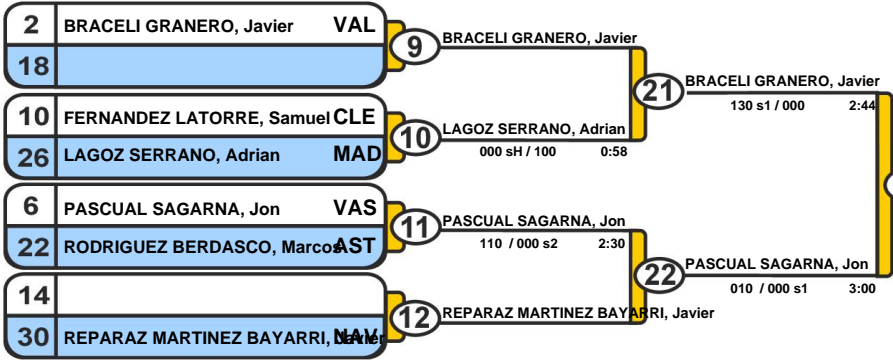

POOL D

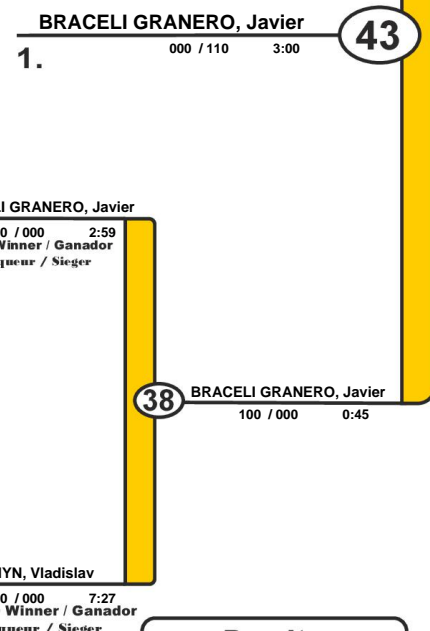
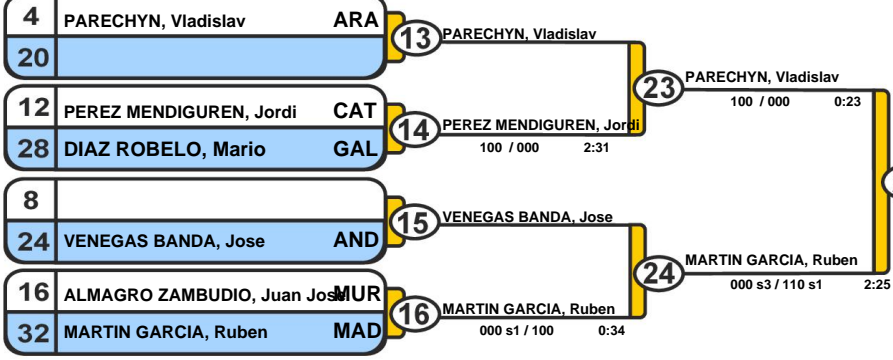

Trostrunde / Repechage / Ronda de consolación

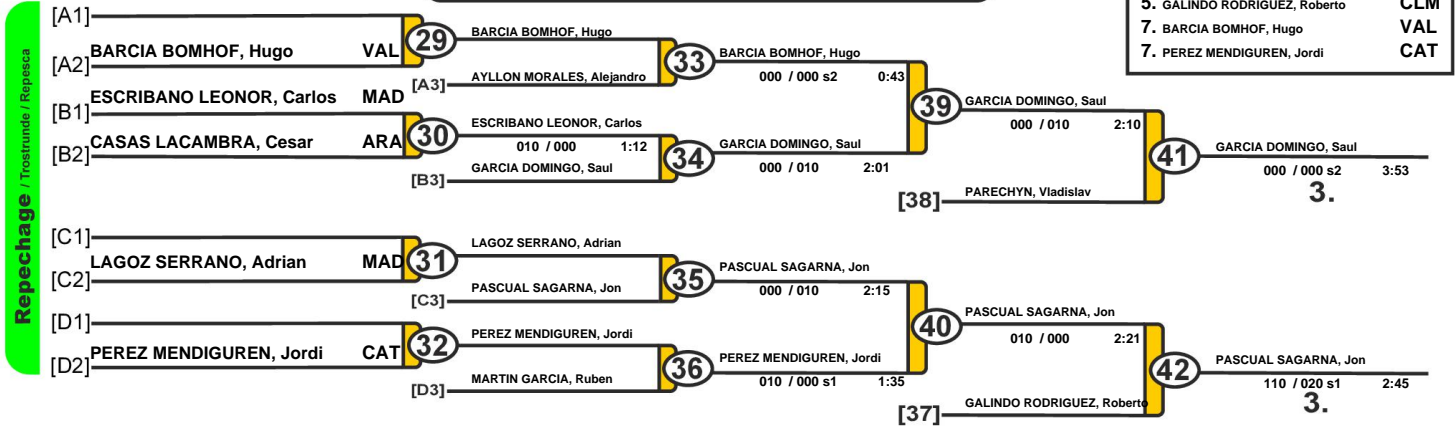

Results	
Resultat / Platzierungen / Resultados	
1.	BRACELI GRANERO, Javier VAL
2.	MAYI HEVILLA, Moises AND
3.	GARCIA DOMINGO, Saul RIO
4.	PASCUAL SAGARNA, Jon VAS
5.	PARECHYN, Vladislav ARA
6.	GALINDO RODRIGUEZ, Roberto CLM
7.	BARCIA BOMHOF, Hugo VAL
8.	PEREZ MENDIGUREN, Jordi CAT



Campeonato de España Escolar 2017

Valencia (ESP), 06-07 May 2017

-90Cad kg

23 Judoka

POOL A

1	SANCHIS REIG, Adrian	VAL
17		
9	SANCHEZ GONZALEZ, Ismael	AST
25	DIAZ JIMENEZ, Ruben	MAD
5	CARPINTERO SALAZAR, Sebastian	CAT
21	TEJERA GONZALEZ, Mahy	CAN
13	BAEZA ALCANTARA, Angel	MUR
29		

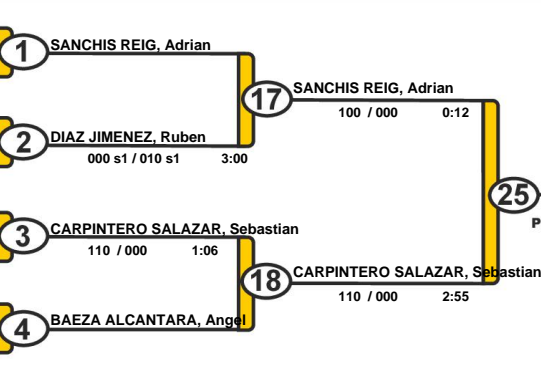

POOL B

3	DUENAS VARGAS, Juan Carlos	CLE
19		
11	ACOSTA ANSELMO, Raul	EXT
27	DIEZ GONZALEZ, Nicolas	NAV
7		
23	LANDA VERA, Enrique	MAD
15	EIZAGUIRRE ATXEGA, Eneko	VAS
31	STETENCO, Abdul Karim	MEL

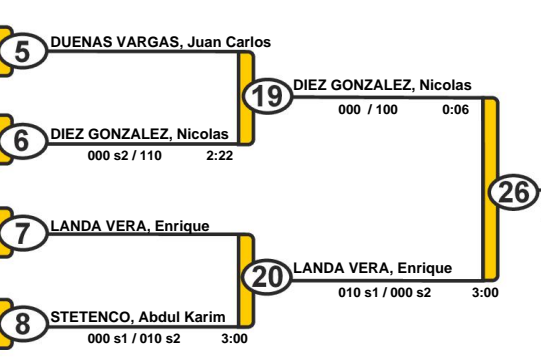

POOL C

2	LOTRO TORRES, Hector	NAV
18		
10	RODRIGUEZ GONZALEZ, Jose Maria	AND
26	ALBEROLA VALVERDE, Ivan	VAL
6	RODRIGUEZ ALVAREZ, Eloy	ARA
22	MORALES GIL, Ruben	CLM
14	CONTRERAS TABOADA, Gerard	MAD
30		

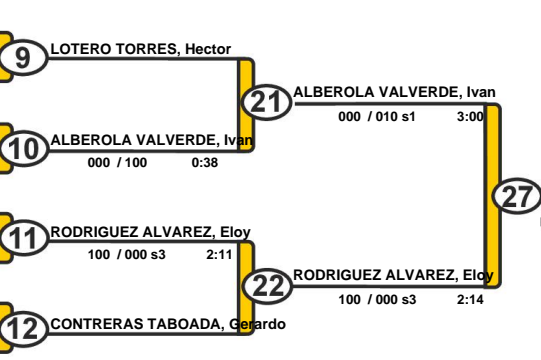

POOL D

4	GARCIA ALONSO, Raul	AST
20		
12	RODRIGUEZ GALLARDO, Francisco Javier	AND
28	ULECIA DE LA FUENTE, Santiago	MAD
8	GONZALEZ BACIGALUPO, Andres	BAL
24		
16		
32	ROMERO PARRA, Julio	RIO

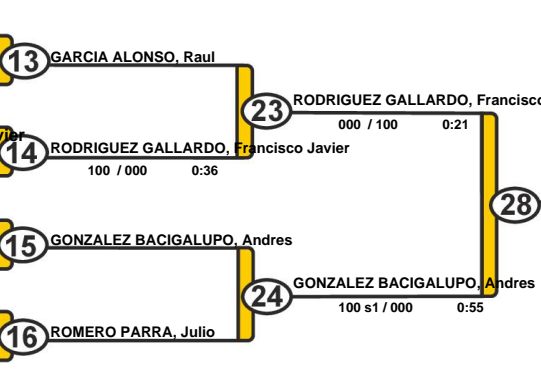

Trostrunde / Repechage / Ronda de consolación

Repechage / Trostrunde / Repesca

[A1]		
[A2]	DIAZ JIMENEZ, Ruben (MAD)	29 DIAZ JIMENEZ, Ruben (MAD)
[B1]	ACOSTA ANSELMO, Raul (EXT)	30 DUENAS VARGAS, Juan Carlos (CLE)
[B2]	DUENAS VARGAS, Juan Carlos (CLE)	30 DUENAS VARGAS, Juan Carlos (CLE)
[C1]	RODRIGUEZ GONZALEZ, Jose Maria (AND)	31 LOTERO TORRES, Hector (NAV)
[C2]	LOTERO TORRES, Hector (NAV)	31 LOTERO TORRES, Hector (NAV)
[D1]	ULECIA DE LA FUENTE, Santiago (MAD)	32 GARCIA ALONSO, Raul (AST)
[D2]	GARCIA ALONSO, Raul (AST)	32 GARCIA ALONSO, Raul (AST)

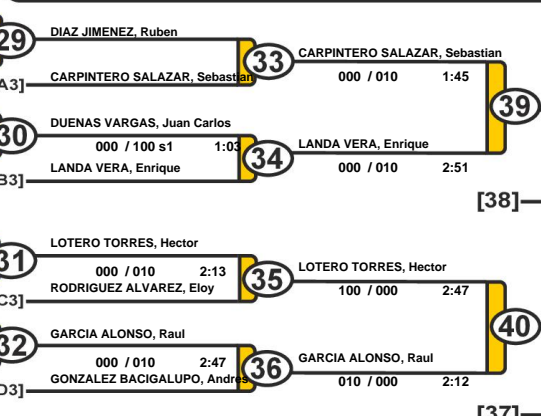

Results	
Resultat / Platzierungen / Resultados	
1.	SANCHIS REIG, Adrian VAL
2.	RODRIGUEZ GALLARDO, Francisco Javier AND
3.	CARPINTERO SALAZAR, Sebastian CAT
4.	LOTRO TORRES, Hector NAV
5.	ALBEROLA VALVERDE, Ivan VAL
6.	DIEZ GONZALEZ, Nicolas NAV
7.	LANDA VERA, Enrique MAD
8.	GARCIA ALONSO, Raul AST



Campeonato de España Escolar 2017

Valencia (ESP), 06-07 May 2017

+90Cad kg

21 Judoka

POOL A

1	CALVO GARCIA, Alejandro	MAD
17		
9	RIVERO BEN-MOHAMED, Israel	CAN
25	BAS CEBE, Ruben	VAL
5		
21	MARIN BERDONCES, Pablo	NAV
13	VAZQUEZ FERNANDEZ, Eloy	GAL
29		



POOL B

3		
19	SAEZ PASCUAL, Victor Javier	MAD
11	FERNANDEZ MONJE, Hugo	AST
27	LABAYEN BASTARRIKA, Jon	VAS
7		
23	LOPEZ BLANCA, Miguel Angel	AND
15	HUELGA MANZANO, Miguel	CTB
31	PARA CASTEJON, Arturo	MUR

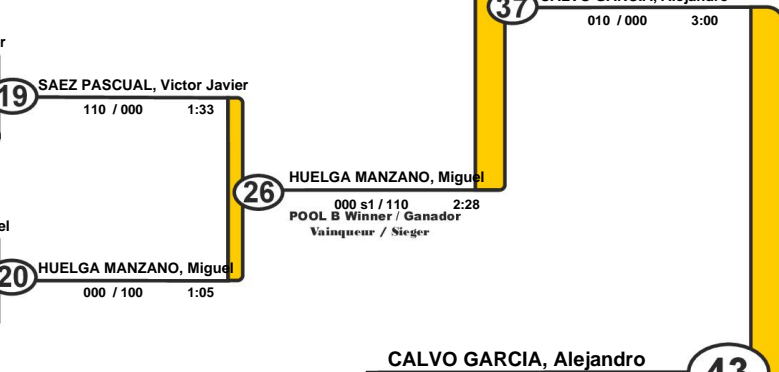

POOL C

2	SALVADO CARRILLO, Martin	GAL
18		
10	GUISADO SERRANO, Roberto	MAD
26	ABDESELAM MOHAMEDI, Aaron	MEL
6		
22	VELASQUEZ TRONCOSO, Algeld	MAD
14		
30	BUSTOS VALERA, Jaime	CLM

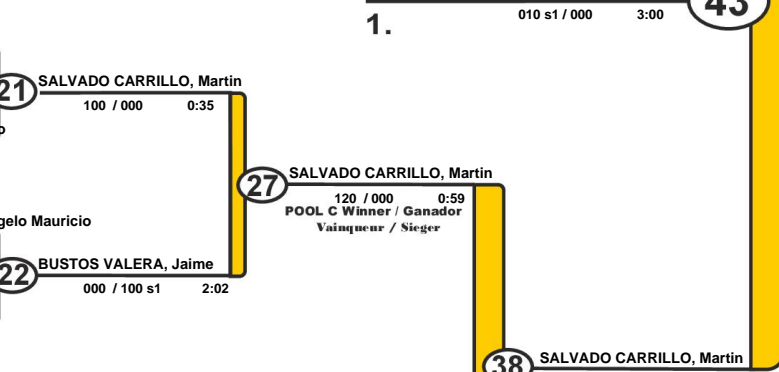

POOL D

4	DIAZ FERNANDEZ, Sergio	AST
20		
12	VLAZQUEZ MERENCIANO, Roge	CAT
28	ESTEBAN LARRAZ, Juan	ARA
8		
24	ESPEJO AGUILERA, Juan Carlos	MAD
16		
32	LOPEZ LOPEZ, Maxi	VAL

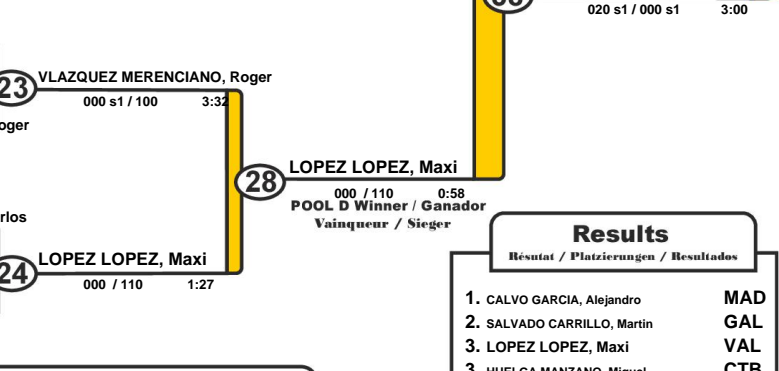

Trostrunde / Repechage / Ronda de consolación

Repechage / Trostrunde / Repechage

[A1]		
[A2]	BAS CEBE, Ruben	VAL
[B1]	PARA CASTEJON, Arturo	MUR
[B2]	LOPEZ BLANCA, Miguel Angel	AND
[C1]	GUISADO SERRANO, Roberto	MAD
[C2]		
[D1]	ESPEJO AGUILERA, Juan Carlos	MAD
[D2]		

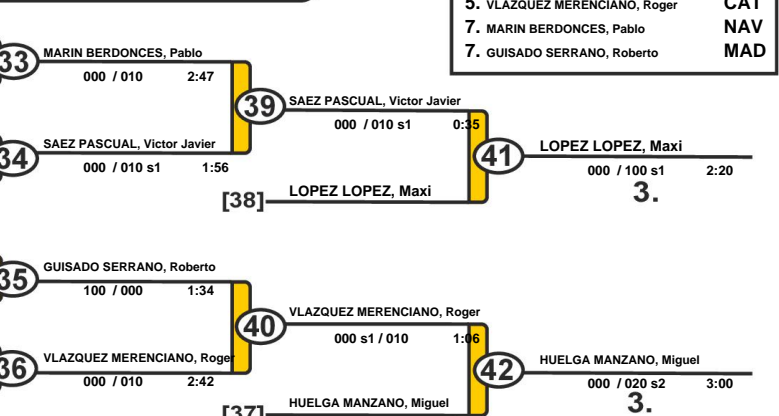

Results	
Resultat / Platzierungen / Resultados	
1.	CALVO GARCIA, Alejandro MAD
2.	SALVADO CARRILLO, Martin GAL
3.	LOPEZ LOPEZ, Maxi VAL
4.	HUELGA MANZANO, Miguel CTB
5.	SAEZ PASCUAL, Victor Javier MAD
6.	VLAZQUEZ MERENCIANO, Roge CAT
7.	MARIN BERDONCES, Pablo NAV
8.	GUISADO SERRANO, Roberto MAD



Campeonato de España Escolar 2017

Valencia (ESP), 06-07 May 2017

-36Inf kg

19 Judoka

POOL A

1	LAZARO SAIZ, Aira	CAT
17		
9	LLOVERA VERDET, Marina	VAL
25	LAVADO ZORILLA, Zaira	MAD
5	FERNANDEZ ALONSO, Eva	CLE
21		
13	GONZALEZ VALVERDE, Alba	EXT
29		

1	LAZARO SAIZ, Aira
17	LAZARO SAIZ, Aira 110 / 000 0:49
2	LAVADO ZORILLA, Zaira 000 s1 / 100 0:49
3	FERNANDEZ ALONSO, Eva
18	GONZALEZ VALVERDE, Alba 000 / 100 0:06
4	GONZALEZ VALVERDE, Alba

25 LAZARO SAIZ, Aira
110 / 000 s2 1:29
POOL A Winner / Ganador
Vainqueur / Sieger

37 LAZARO SAIZ, Aira
110 / 000 2:54

POOL B

3		
19	GONZALEZ ARROYO, Valle	CAT
11		
27	PUGA PRESEDO, Candela	GAL
7	COVIELLA MUNOZ, Marina	AST
23		
15	FERNANDEZ SERRANO, Helena	MAD
31		

5	GONZALEZ ARROYO, Valle
19	GONZALEZ ARROYO, Valle 110 / 000 1:00
6	PUGA PRESEDO, Candela
7	COVIELLA MUNOZ, Marina
20	COVIELLA MUNOZ, Marina 100 / 040 2:18
8	FERNANDEZ SERRANO, Helena

26 GONZALEZ ARROYO, Valle
100 / 000 0:08
POOL B Winner / Ganador
Vainqueur / Sieger

LAZARO SAIZ, Aira
1. 120 / 010 1:29 **43**

POOL C

2	PENAS FORNE, Natalia	CAT
18		
10		
26	SANZ PRIETO, Nerea	CLM
6	DE ANDRES GASCON, Maria	MAD
22	LEAL PAUSANOS, Ana Julia	NAV
14		
30	SERRANO GARCIA-BALLESTERAS, Sara	ARS

9	PENAS FORNE, Natalia
21	PENAS FORNE, Natalia 110 / 000 0:31
10	SANZ PRIETO, Nerea
11	LEAL PAUSANOS, Ana Julia 000 / 100 0:17
22	LEAL PAUSANOS, Ana Julia 110 / 000 0:35
12	SERRANO GARCIA-BALLESTERAS, Sara

27 LEAL PAUSANOS, Ana Julia
000 s1 / 020 s1 3:00
POOL C Winner / Ganador
Vainqueur / Sieger

38 LEAL PAUSANOS, Ana Julia
110 / 000 2:17

POOL D

4	POWELL ALVARO, Hannah	RIO
20		
12	NIETO FORESTI, Sofia	BAL
28	CID BALCELLS, Paula	CAT
8		
24	MARCHENA BARBAS, Andrea	MAD
16	ALONSO GOMEZ, Ainhoa	VAS
32		

13	POWELL ALVARO, Hannah
23	CID BALCELLS, Paula 000 s1 / 120 s1 2:43
14	CID BALCELLS, Paula 000 / 120 2:14
15	MARCHENA BARBAS, Andrea
24	MARCHENA BARBAS, Andrea 100 / 000 1:22
16	ALONSO GOMEZ, Ainhoa

28 CID BALCELLS, Paula
030 / 000 3:00
POOL D Winner / Ganador
Vainqueur / Sieger

Results	
Résultat / Platzierungen / Resultados	
1.	LAZARO SAIZ, Aira CAT
2.	LEAL PAUSANOS, Ana Julia NAV
3.	CID BALCELLS, Paula CAT
3.	GONZALEZ ARROYO, Valle CAT
5.	PUGA PRESEDO, Candela GAL
5.	PENAS FORNE, Natalia CAT
7.	LAVADO ZORILLA, Zaira MAD
7.	MARCHENA BARBAS, Andrea MAD

Trostrunde / Repechage / Ronda de consolação

Repechage / Trostrunde / Repesca

[A1]		
[A2]	LAVADO ZORILLA, Zaira	MAD
[B1]		
[B2]	PUGA PRESEDO, Candela	GAL
[C1]	DE ANDRES GASCON, Maria	MAD
[C2]	SERRANO GARCIA-BALLESTERAS, Sara	ARS
[D1]		
[D2]	POWELL ALVARO, Hannah	RIO

29	LAVADO ZORILLA, Zaira
33	LAVADO ZORILLA, Zaira 010 / 000 1:48
[A3]	GONZALEZ VALVERDE, Alba
30	PUGA PRESEDO, Candela
34	PUGA PRESEDO, Candela 010 s1 / 000 s1 1:28
[B3]	COVIELLA MUNOZ, Marina
31	DE ANDRES GASCON, Maria 100 / 000 0:00
35	PENAS FORNE, Natalia 000 / 010 1:45
[C3]	PENAS FORNE, Natalia
32	POWELL ALVARO, Hannah 000 / 010 2:19
36	MARCHENA BARBAS, Andrea 000 s1 / 010 1:08
[D3]	MARCHENA BARBAS, Andrea

39 PUGA PRESEDO, Candela
000 / 010 2:34

41 CID BALCELLS, Paula
000 / 110 0:32

[38] CID BALCELLS, Paula **3.**

40 PENAS FORNE, Natalia
010 / 000 2:35

42 GONZALEZ ARROYO, Valle
000 / 110 0:28

[37] GONZALEZ ARROYO, Valle **3.**



Campeonato de España Escolar 2017

Valencia (ESP), 06-07 May 2017

-40Inf kg

22 Judoka

POOL A

1	REQUE JUNCO, Claudia	CLE	1	REQUE JUNCO, Claudia
17			17	REQUE JUNCO, Claudia
9	PAVALACHI CUENCA, Lara	ARA	2	ROMEU ROLDAN, Raquel
25	ROMEU ROLDAN, Raquel	CAT		000 / 100 s1 1:26
5	LEMOS GONZALEZ, Ainhoa	VAS	3	LEMOS GONZALEZ, Ainhoa
21			18	LEMOS GONZALEZ, Ainhoa
13			4	RAMIL PORRAS, Marta
29	RAMIL PORRAS, Marta	MAD		110 / 010 1:44

POOL B

3	ARROYO ALARCON, Alejandra	MAD	5	JUAREZ LOPEZ, Olga
19	JUAREZ LOPEZ, Olga	CAT		010 s1 / 020 3:00
11	DOMINGO AYALA, Clara	AND	6	DOMINGO AYALA, Clara
27			19	DOMINGO AYALA, Clara
7	SANCHEZ GARCIA, Patricia	AST	7	SANCHEZ GARCIA, Patricia
23			20	CANO VILLAMOR, Sara
15	PEREZ SOLER, Laura	BAL	8	CANO VILLAMOR, Sara
31	CANO VILLAMOR, Sara	MAD		010 / 110 1:29

POOL C

2	ESPARZA RIVERA, Rebeca	MAD	9	ESPARZA RIVERA, Rebeca
18			21	ESPARZA RIVERA, Rebeca
10	SANCHEZ MEDINA, Belen	AND	10	ROVIRA LEON, Silvia
26	ROVIRA LEON, Silvia	VAL		000 s2 / 120 s1 2:13
6			11	PEREZ CAMACHO, Elena
22	PEREZ CAMACHO, Elena	MUR		010 / 000 s2 3:28
14	GONZALEZ MACHADO, Alba	GAL	12	GONZALEZ MACHADO, Alba
30			22	GONZALEZ MACHADO, Alba

POOL D

4	QUEROL ILARI, Isabel	CAT	13	QUEROL ILARI, Isabel
20			23	BULDAIN ELIZALDE, Joane
12	BULDAIN ELIZALDE, Joane	NAV		000 s1 / 010 s1 4:04
28	BONILLA COBO, Andrea	CTB	14	BULDAIN ELIZALDE, Joane
				010 / 000 3:00
8	VILLEGAS SANTOS, Patricia	MAD	15	VILLEGAS SANTOS, Patricia
24			24	MATEOS GARCIA, Carla
16	MATEOS GARCIA, Carla	CLE		000 s1 / 100 2:39
32	DRUMMOND DEEVES, Mati Talu	CAN	16	MATEOS GARCIA, Carla
				110 / 000 s1 0:57

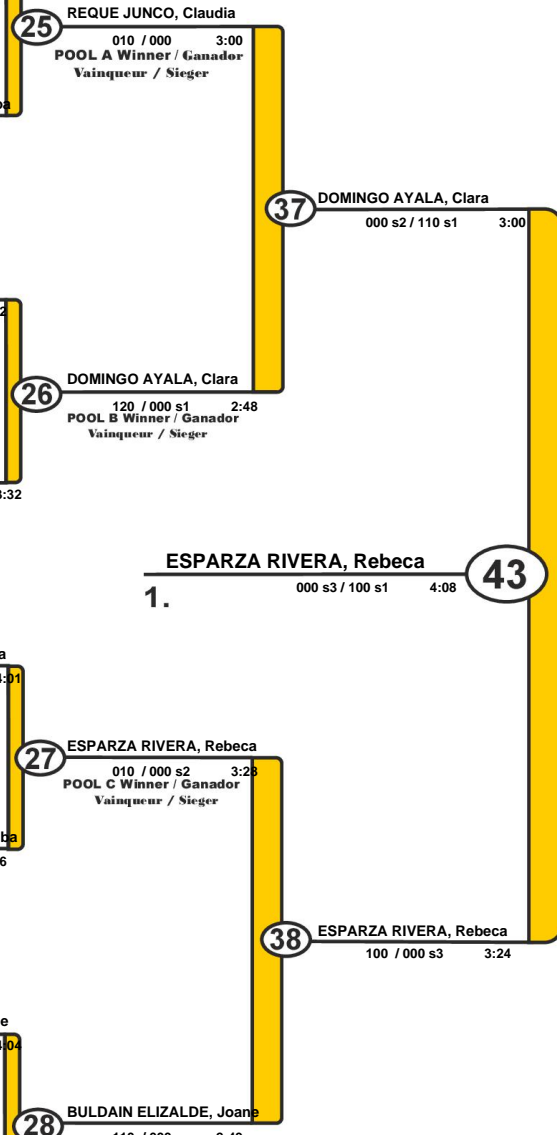

Results		
Resultat / Platzierungen / Resultados		
1.	ESPARZA RIVERA, Rebeca	MAD
2.	DOMINGO AYALA, Clara	AND
3.	BULDAIN ELIZALDE, Joane	NAV
3.	REQUE JUNCO, Claudia	CLE
5.	ROMEU ROLDAN, Raquel	CAT
7.	CANO VILLAMOR, Sara	MAD
7.	ROVIRA LEON, Silvia	VAL

Trostrunde / Repechage / Ronda de consolación

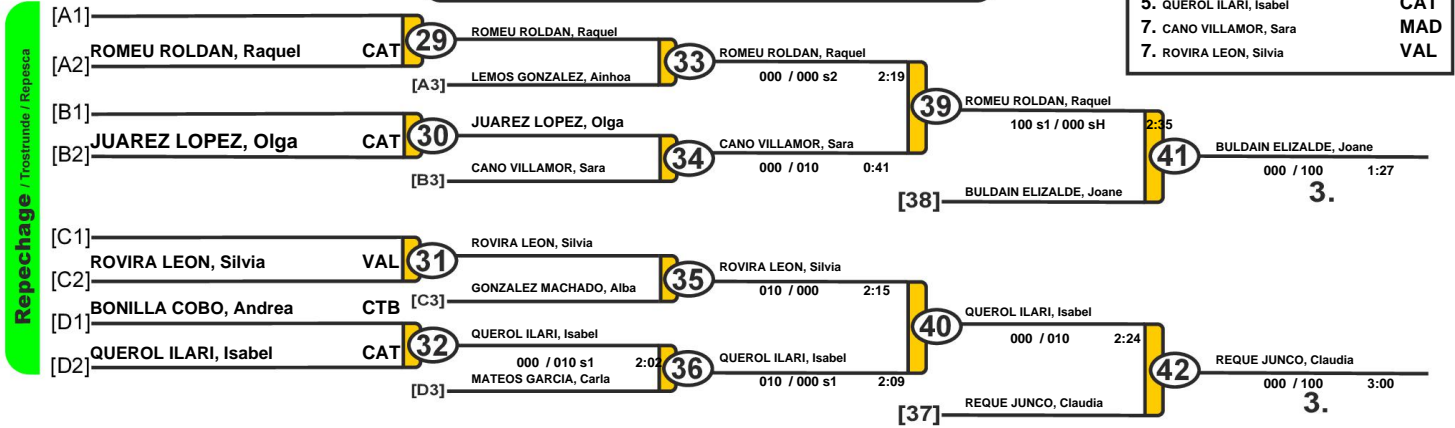



Campeonato de España Escolar 2017

Valencia (ESP), 06-07 May 2017

-44Inf kg

23 Judoka

POOL A



POOL B

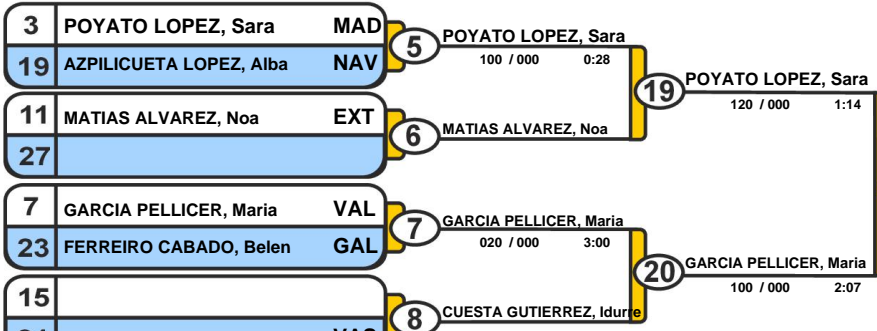

POOL C

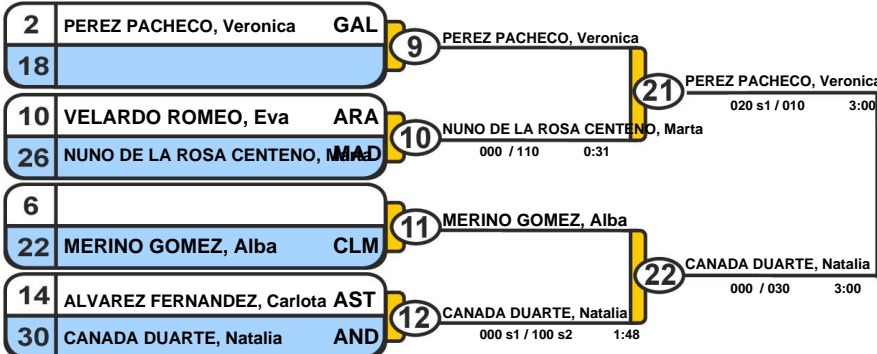

POOL D

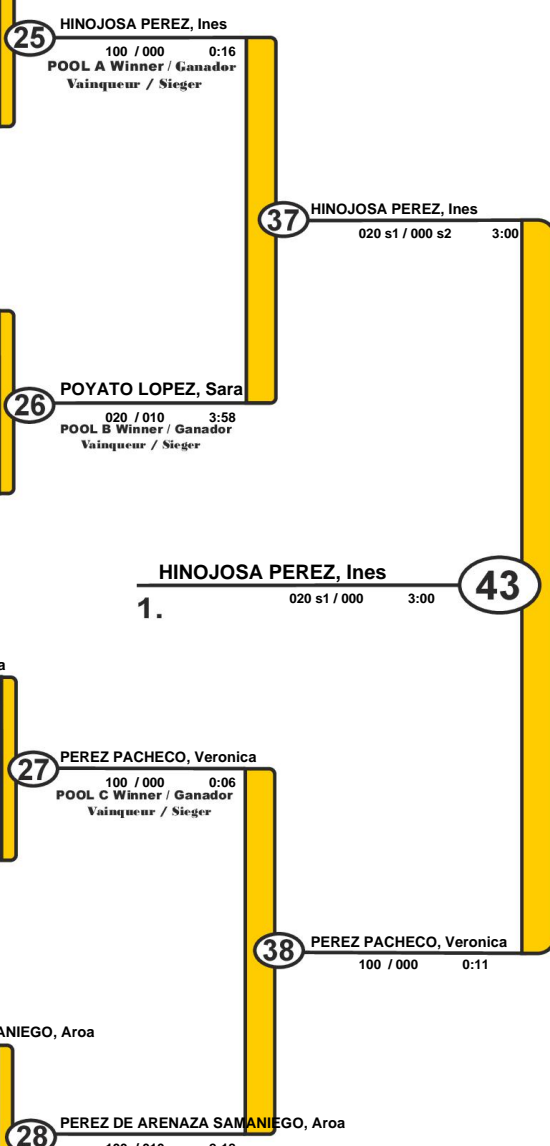
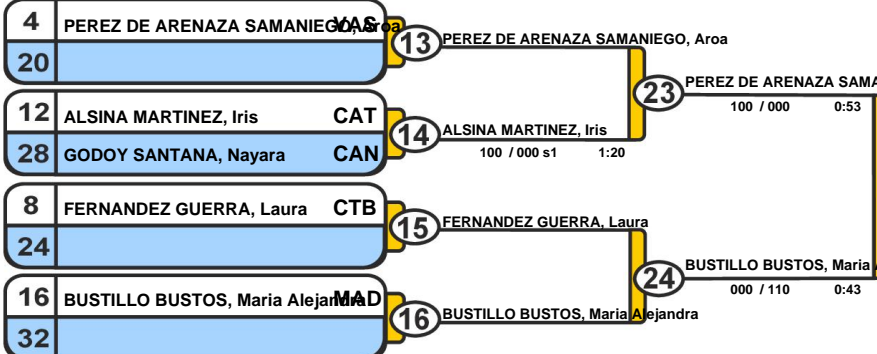

Trostrunde / Repechage / Ronda de consolación

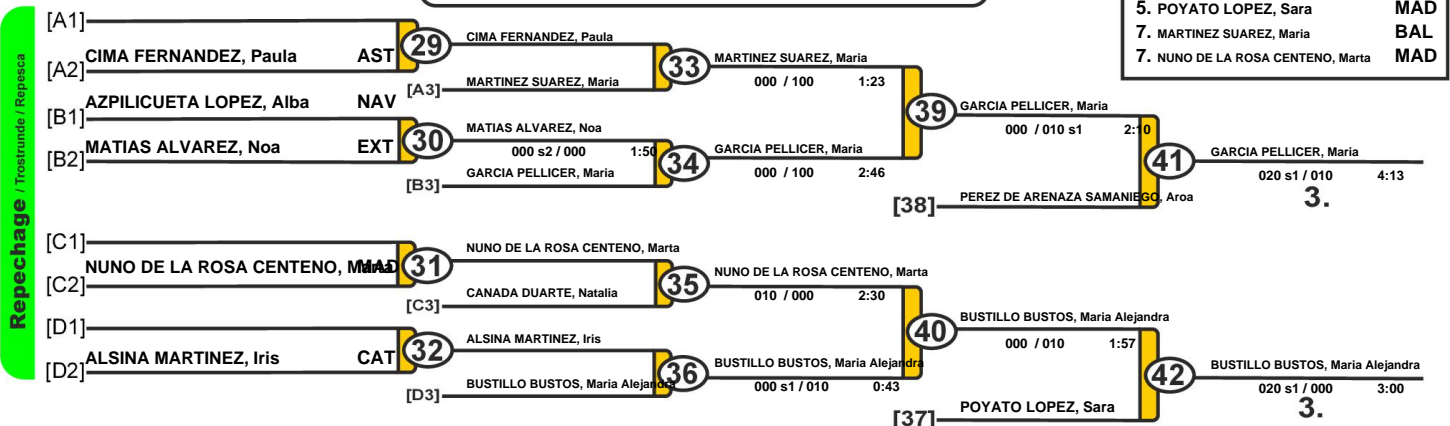

Results	
Resultat / Platzierungen / Resultados	
1.	HINOJOSA PEREZ, Ines ARA
2.	PEREZ PACHECO, Veronica GAL
3.	GARCIA PELLICER, Maria VAL
4.	BUSTILLO BUSTOS, Maria Alejandra MAD
5.	PEREZ DE ARENAZA SAMANIEGO, Aroa VAS
6.	POYATO LOPEZ, Sara MAD
7.	MARTINEZ SUAREZ, Maria BAL
8.	NUNO DE LA ROSA CENTENO, Marta MAD



Campeonato de España Escolar 2017

Valencia (ESP), 06-07 May 2017

-48Inf kg

28 Judoka

POOL A

1	JUAN MARTINEZ, Paula	MAD	1	JUAN MARTINEZ, Paula	
17			17	JUAN MARTINEZ, Paula	110 / 010 s1 1:16
9	LOMBA QUINTAS, Carla	GAL	2	ARREGI MIGUEL, Anne Miren	000 s1 / 110 1:24
25	ARREGI MIGUEL, Anne Miren	VAS	25	JUAN MARTINEZ, Paula	020 s1 / 010 3:45 POOL A Winner / Ganador Vainqueur / Sieger
5	MARTIN DE PIEDAD, Martina	CAN	3	MARTIN DE PIEDAD, Martina	130 / 000 s1 2:43
21	SILIO MAZA, Paula	CTB	18	RUBIO GARCIA-SOTO, Andrea	000 / 100 1:03
13	ENRIQUEZ PEREZ, Julia	AST	4	RUBIO GARCIA-SOTO, Andrea	000 / 100 1:04
29	RUBIO GARCIA-SOTO, Andrea	VAL			

POOL B

3	TORO SOLER, Ariane	NAV	5	TORO SOLER, Ariane	
19			19	TORO SOLER, Ariane	110 / 000 0:32
11	LARA VIDAURRAZAGA, Noa	RIO	6	LARA VIDAURRAZAGA, Noa	100 / 000 s1 2:06
27	VALLEJO ROMERO, Minerva	CLM	26	TORO SOLER, Ariane	140 / 000 2:04 POOL B Winner / Ganador Vainqueur / Sieger
7	FERNANDEZ SANCHEZ, Paula	AND	7	FERNANDEZ SANCHEZ, Paula	010 / 000 3:10
23	CARNICERTO LOPEZ, Marta	MAD	20	GUERRERO DONAT, Aitana	000 / 010 3:48
15	GUERRERO DONAT, Aitana	VAL	8	GUERRERO DONAT, Aitana	100 / 000 0:48
31	MOLINA GRANDE, Miriam	MAD			

POOL C

2	RODRIGUEZ SALVADOR, Adrian	VAL	9	RODRIGUEZ SALVADOR, Adriana	
18			21	FERNANDEZ SANCHEZ, Elisa	000 / 100 0:00
10	CARRETERO SORIA, Maria	MAD	10	FERNANDEZ SANCHEZ, Elisa	000 / 110 s1 2:04
26	FERNANDEZ SANCHEZ, Elisa	AST	27	FERNANDEZ SANCHEZ, Elisa	110 / 010 s3 2:19 POOL C Winner / Ganador Vainqueur / Sieger
6	DIAZ HARO, Julia Ye	AND	11	LOPEZ MARTINEZ, Sofia	000 s2 / 010 s1 3:00
22	LOPEZ MARTINEZ, Sofia	GAL	22	GUERRERO CONDE, Nora	000 / 020 3:00
14	RAMIREZ GIMENEZ, Alba	ARA	12	GUERRERO CONDE, Nora	000 / 020 3:00
30	GUERRERO CONDE, Nora	CAT			

POOL D

4	BEORLEGUI OSES, Paula	VAS	13	BEORLEGUI OSES, Paula	
20			23	BEORLEGUI OSES, Paula	010 / 000 3:00
12	RODRIGO SOTO, Carmen	CLE	14	GOMEZ ANTONA, Laura	000 / 100 0:08
28	GOMEZ ANTONA, Laura	MAD	28	BEORLEGUI OSES, Paula	110 s1 / 000 2:21 POOL D Winner / Ganador Vainqueur / Sieger
8	SARALEGI LORENZO, Amaia	NAV	15	PERPETUO MARTINEZ, Noelia	000 / 120 1:17
24	PERPETUO MARTINEZ, Noelia	GAL	24	PERPETUO MARTINEZ, Noelia	020 s1 / 010 3:29
16	PREGONAS SILVESTRE, Naia	VAL	16	PREGONAS SILVESTRE, Naia	020 / 010 s1 3:00
32	ROBERT TORRENT, Edith	BAL			

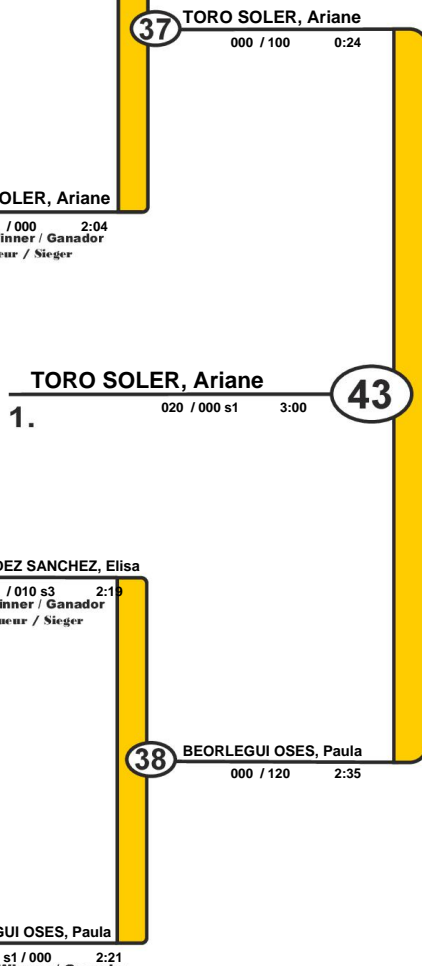

Results	
Résultat / Platzierungen / Resultados	
1.	TORO SOLER, Ariane NAV
2.	BEORLEGUI OSES, Paula VAS
3.	FERNANDEZ SANCHEZ, Elisa AST
4.	GOMEZ ANTONA, Laura MAD
5.	RUBIO GARCIA-SOTO, Andrea VAL
6.	JUAN MARTINEZ, Paula MAD
7.	GUERRERO DONAT, Aitana VAL
8.	GUERRERO CONDE, Nora CAT

Trostrunde / Repechage / Ronda de consolación

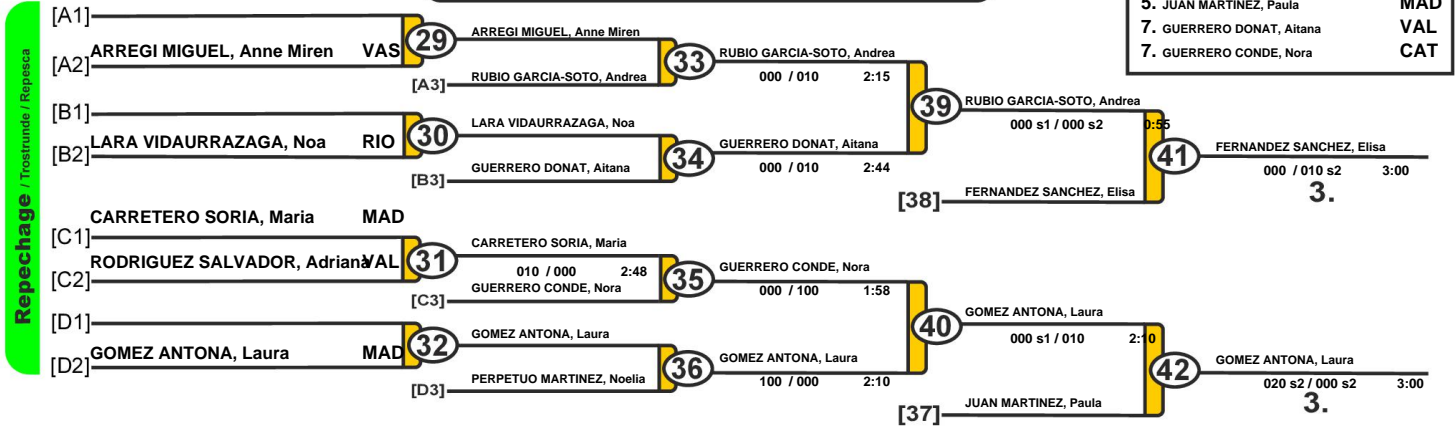



Campeonato de España Escolar 2017

Valencia (ESP), 06-07 May 2017

-52Inf kg

27 Judoka

POOL A

1	BARREIRO GONZALEZ, Alba	AST	1	BARREIRO GONZALEZ, Alba
17			17	BARREIRO GONZALEZ, Alba
9	SOLBES CONDADO, Maria	VAL	2	SOLBES CONDADO, Maria
25	GONZALEZ DA COSTA EVANGELINA, Noa	AST	2	SOLBES CONDADO, Maria
5	SERAFIN RODRIGUEZ, Leticia	CAN	3	SANCHEZ ARRASTIA, Lucia
21	SANCHEZ ARRASTIA, Lucia	NAV	3	SANCHEZ ARRASTIA, Lucia
13	GONZALEZ RUIZ, Agueda	MUR	4	GONZALEZ RUIZ, Agueda
29	MORALES VALLES, Marta	MAD	4	GONZALEZ RUIZ, Agueda

POOL B

3			5	KONARE SISSOKO, Deniba
19	KONARE SISSOKO, Deniba	VAS	5	KONARE SISSOKO, Deniba
11	NEVADO GARCIA, Atenea	CLM	6	ROMERO GUTIERREZ, Irene
27	ROMERO GUTIERREZ, Irene	CAT	6	ROMERO GUTIERREZ, Irene
7	SANCHEZ MUNOZ, Vanessa	MAD	7	SANCHEZ MUNOZ, Vanessa
23	SOSA AGUADO, Marina	BAL	7	SANCHEZ MUNOZ, Vanessa
15	ARANCON GARCIA, Silvia	CLE	8	ARANCON GARCIA, Silvia
31			8	ARANCON GARCIA, Silvia

POOL C

2	BEAUSSE SIRO, Melany	VAL	9	BEAUSSE SIRO, Melany
18			9	BEAUSSE SIRO, Melany
10	MARTINEZ DE RITUERTO MORILLAS, Irene	MAD	10	MARTINEZ DE RITUERTO MORILLAS, Irene
26	CORREA MARTIN, Beatriz	AND	10	MARTINEZ DE RITUERTO MORILLAS, Irene
6	MARTINEZ OCHOA, Carmen	RIO	11	MARTINEZ OCHOA, Carmen
22	RASCON PEREZ, Lesley	ARA	11	MARTINEZ OCHOA, Carmen
14	SOLA GIRO, Claudia	CAT	12	GARCIA CORRAL, Celia
30	GARCIA CORRAL, Celia	EXT	12	GARCIA CORRAL, Celia

POOL D

4	CORNEJO MARTIN, Paola	CLE	13	CORNEJO MARTIN, Paola
20			13	CORNEJO MARTIN, Paola
12	FANJUL SAAVEDRA, Rosa	AST	14	FANJUL SAAVEDRA, Rosa
28	TORRALBA MARTINEZ, Luaura	CTB	14	FANJUL SAAVEDRA, Rosa
8	GUTIERREZ RIOJA, Alba	MAD	15	LAGE RIVERA, Sabela
24	LAGE RIVERA, Sabela	GAL	15	LAGE RIVERA, Sabela
16	CAPOBIANCO MENDEZ, Carla	VAL	16	CAPOBIANCO MENDEZ, Carla
32	VEGA GOMEZ, Julia	CAN	16	CAPOBIANCO MENDEZ, Carla

Trostrunde / Repechage / Ronda de consolación

Repechage / Trostrunde / Repesca

[A1]			29	SOLBES CONDADO, Maria	33	GONZALEZ RUIZ, Agueda
[A2]	SOLBES CONDADO, Maria	VAL	29	SOLBES CONDADO, Maria	33	GONZALEZ RUIZ, Agueda
[A3]						
[B1]			30	ROMERO GUTIERREZ, Irene	34	ROMERO GUTIERREZ, Irene
[B2]	ROMERO GUTIERREZ, Irene	CAT	30	ROMERO GUTIERREZ, Irene	34	ROMERO GUTIERREZ, Irene
[B3]						
[C1]			31	MARTINEZ DE RITUERTO MORILLAS, Irene	35	MARTINEZ OCHOA, Carmen
[C2]	MARTINEZ DE RITUERTO MORILLAS, Irene	MAD	31	MARTINEZ DE RITUERTO MORILLAS, Irene	35	MARTINEZ OCHOA, Carmen
[C3]						
[D1]			32	FANJUL SAAVEDRA, Rosa	40	MARTINEZ OCHOA, Carmen
[D2]	FANJUL SAAVEDRA, Rosa	AST	32	FANJUL SAAVEDRA, Rosa	40	MARTINEZ OCHOA, Carmen
[D3]						
[D4]			36	LAGE RIVERA, Sabela	42	KONARE SISSOKO, Deniba
[D5]	LAGE RIVERA, Sabela	GAL	36	LAGE RIVERA, Sabela	42	KONARE SISSOKO, Deniba
[D6]						

1.	BARREIRO GONZALEZ, Alba	100 / 000	1:24	43
2.	BEAUSSE SIRO, Melany	100 / 000	0:36	38
3.	GONZALEZ RUIZ, Agueda	110 / 000	1:22	41
4.	KONARE SISSOKO, Deniba	000 / 100	0:50	42
5.	CORNEJO MARTIN, Paola	100 / 000	0:37	37
6.	MARTINEZ OCHOA, Carmen	000 s1 / 100 s1	2:37	18
7.	ROMERO GUTIERREZ, Irene	000 s2 / 110 s1	3:00	6
8.	LAGE RIVERA, Sabela	010 / 100	0:47	24
9.	BEAUSSE SIRO, Melany	120 / 000	2:13	21
10.	MARTINEZ DE RITUERTO MORILLAS, Irene	120 / 000 s1	1:01	10
11.	MARTINEZ OCHOA, Carmen	100 / 000	1:31	11
12.	GARCIA CORRAL, Celia	000 s2 / 030 s1	3:00	12
13.	CORNEJO MARTIN, Paola	120 / 000 s1	1:58	23
14.	FANJUL SAAVEDRA, Rosa	100 / 010	1:19	14
15.	LAGE RIVERA, Sabela	010 / 100	0:18	15
16.	CAPOBIANCO MENDEZ, Carla	010 / 000	3:00	16
17.	BARREIRO GONZALEZ, Alba	110 / 000	0:54	17
18.	GONZALEZ RUIZ, Agueda	000 s1 / 100 s1	2:37	18
19.	KONARE SISSOKO, Deniba	100 / 000 s1	0:36	19
20.	SANCHEZ MUNOZ, Vanessa	100 / 010	1:19	20
21.	BEAUSSE SIRO, Melany	120 / 000	2:13	21
22.	MARTINEZ OCHOA, Carmen	120 / 000	1:17	22
23.	ROMERO GUTIERREZ, Irene	000 s2 / 110 s1	3:00	27
24.	LAGE RIVERA, Sabela	010 / 100	0:18	24
25.	BARREIRO GONZALEZ, Alba	110 / 000 s2	1:55	25
26.	KONARE SISSOKO, Deniba	120 s1 / 010 s1	3:00	26
27.	BEAUSSE SIRO, Melany	100 s2 / 000	2:10	27
28.	CORNEJO MARTIN, Paola	110 / 000	1:09	28
29.	SOLBES CONDADO, Maria	100 / 000	1:55	29
30.	ROMERO GUTIERREZ, Irene	000 s1 / 010 s1	2:58	30
31.	MARTINEZ DE RITUERTO MORILLAS, Irene	120 / 000	2:13	31
32.	FANJUL SAAVEDRA, Rosa	010 / 000	2:59	32
33.	GONZALEZ RUIZ, Agueda	000 s1 / 010 s1	2:58	33
34.	ROMERO GUTIERREZ, Irene	100 / 000	2:52	34
35.	MARTINEZ OCHOA, Carmen	000 s1 / 100	1:30	35
36.	LAGE RIVERA, Sabela	000 / 010	2:09	36
37.	KONARE SISSOKO, Deniba	000 / 100	0:37	37
38.	BEAUSSE SIRO, Melany	100 / 000	0:36	38
39.	GONZALEZ RUIZ, Agueda	010 / 000	1:13	39
40.	MARTINEZ OCHOA, Carmen	010 / 000	2:59	40
41.	GONZALEZ RUIZ, Agueda	110 / 000	1:22	41
42.	KONARE SISSOKO, Deniba	000 / 100	0:50	42
43.	BARREIRO GONZALEZ, Alba	100 / 000	1:24	43

Results	
Resultat / Platzierungen / Resultados	
1.	BARREIRO GONZALEZ, Alba AST
2.	BEAUSSE SIRO, Melany VAL
3.	GONZALEZ RUIZ, Agueda MUR
4.	KONARE SISSOKO, Deniba VAS
5.	CORNEJO MARTIN, Paola CLE
6.	MARTINEZ OCHOA, Carmen RIO
7.	ROMERO GUTIERREZ, Irene CAT
7.	LAGE RIVERA, Sabela GAL



Campeonato de España Escolar 2017

Valencia (ESP), 06-07 May 2017

-57Inf kg

25 Judoka

POOL A

1	GIMENO TRICOT, Natasha	VAL	1	GIMENO TRICOT, Natasha
17			17	GIMENO TRICOT, Natasha
9	LOPEZ MADJESKA, Ana Maria	MUR	2	DUBLAN ZUBIETA, Ainhoa
25	DUBLAN ZUBIETA, Ainhoa	NAV	2	DUBLAN ZUBIETA, Ainhoa
5	GARCIA DEL PESO, Irene	MAD	3	GARCIA ISARDO, Aitana
21	GARCIA ISARDO, Aitana	AST	3	GARCIA ISARDO, Aitana
13			4	GUTIERREZ CABEZON, Nuria
29	GUTIERREZ CABEZON, Nuria	RIO	4	GUTIERREZ CABEZON, Nuria

POOL B

3	PINEDA PEREZ, Amaya	NAV	5	CASANAS ACEDO, Judit
19	CASANAS ACEDO, Judit	CAT	5	CASANAS ACEDO, Judit
11			6	BLANCO MATESANZ, Patricia
27	BLANCO MATESANZ, Patricia	MAD	6	BLANCO MATESANZ, Patricia
7	DIAZ MUNOZ, Maria Del Mar	AND	7	DIAZ MUNOZ, Maria Del Mar
23	BALLESTEROS SAIZ, Noelia	VAL	7	DIAZ MUNOZ, Maria Del Mar
15			8	MALLEN MAINER, Lucia
31	MALLEN MAINER, Lucia	ARA	8	MALLEN MAINER, Lucia

POOL C

2	TORRES LUMBRERAS, Valeria	VAL	9	TORRES LUMBRERAS, Valeria
18			9	TORRES LUMBRERAS, Valeria
10	GARCIA MONTANO, Paula	CLE	10	DOMINGUEZ RODRIGO, Lucia
26	DOMINGUEZ RODRIGO, Lucia	MAD	10	DOMINGUEZ RODRIGO, Lucia
6	NUNEZ MARI, Yaiza	BAL	11	CATENA ANDUEZA, Saioa
22	CATENA ANDUEZA, Saioa	NAV	11	CATENA ANDUEZA, Saioa
14	HIDALGO CLAUSIN, Marina	CAT	12	HIDALGO CLAUSIN, Marina
30			12	HIDALGO CLAUSIN, Marina

POOL D

4	FERNANDEZ HERRERA, Aitana	VAL	13	FERNANDEZ HERRERA, Aitana
20			13	FERNANDEZ HERRERA, Aitana
12	CAMARGO BELMAR, Andrea	MAD	14	VOLO MACHIN, Laura
28	VOLO MACHIN, Laura	CAN	14	VOLO MACHIN, Laura
8	ZARCO PEINADO, Irene	CLM	15	ZARCO PEINADO, Irene
24	LOPEZ PEON, Alicia	GAL	15	ZARCO PEINADO, Irene
16	LERCHUNDI SERRANO, Loraine	VAS	16	LERCHUNDI SERRANO, Loraine
32	LOPEZ DORIGA TAMARGO, Lucia	CTB	16	LERCHUNDI SERRANO, Loraine

Trostrunde / Repechage / Ronda de consolación

[A1]			29	DUBLAN ZUBIETA, Ainhoa	33	GUTIERREZ CABEZON, Nuria
[A2]	DUBLAN ZUBIETA, Ainhoa	NAV	[A3]	GUTIERREZ CABEZON, Nuria	33	GUTIERREZ CABEZON, Nuria
[B1]			30	CASANAS ACEDO, Judit	34	CASANAS ACEDO, Judit
[B2]	CASANAS ACEDO, Judit	CAT	[B3]	MALLEN MAINER, Lucia	34	CASANAS ACEDO, Judit
[C1]			31	DOMINGUEZ RODRIGO, Lucia	35	CATENA ANDUEZA, Saioa
[C2]	DOMINGUEZ RODRIGO, Lucia	MAD	[C3]	CATENA ANDUEZA, Saioa	35	CATENA ANDUEZA, Saioa
[D1]			32	VOLO MACHIN, Laura	36	LERCHUNDI SERRANO, Loraine
[D2]	VOLO MACHIN, Laura	CAN	[D3]	LERCHUNDI SERRANO, Loraine	36	LERCHUNDI SERRANO, Loraine

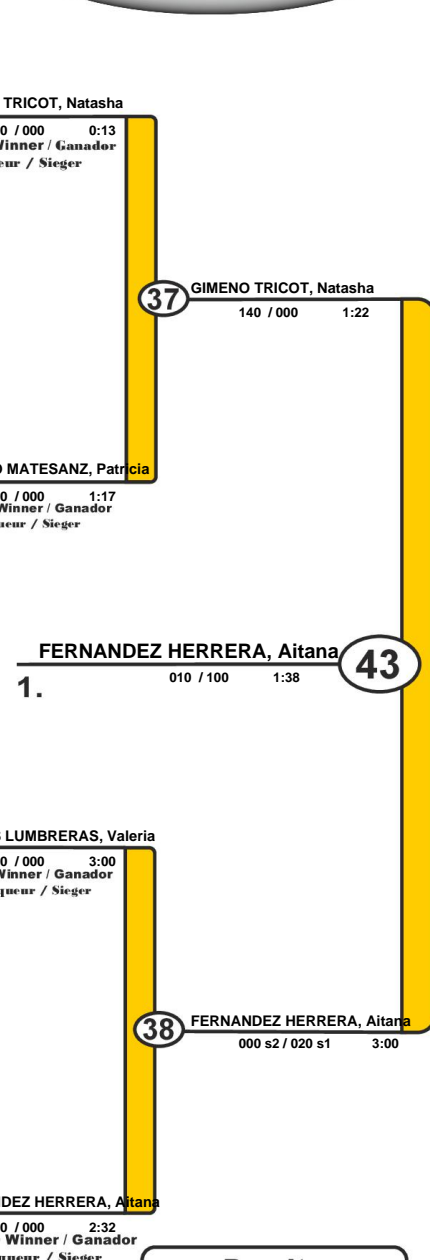

Results		
Resultat / Platzierungen / Resultados		
1.	FERNANDEZ HERRERA, Aitana	VAL
2.	GIMENO TRICOT, Natasha	VAL
3.	TORRES LUMBRERAS, Valeria	VAL
3.	BLANCO MATESANZ, Patricia	MAD
5.	GUTIERREZ CABEZON, Nuria	RIO
5.	CATENA ANDUEZA, Saioa	NAV
7.	CASANAS ACEDO, Judit	CAT
7.	LERCHUNDI SERRANO, Loraine	VAS



Campeonato de España Escolar 2017

Valencia (ESP), 06-07 May 2017

-63Inf kg

22 Judoka

POOL A

1	DIEZ RODRIGUEZ, Janire	VAS	1	DIEZ RODRIGUEZ, Janire
17			17	DIEZ RODRIGUEZ, Janire
9	GONZALEZ TEJERA, Irene	CTB	2	SOUTO GONZALEZ, Melania
25	SOUTO GONZALEZ, Melania	AST	2	000 / 110 0:50
5	LUCENA TAPIA, Lucia	MAD	3	LUCENA TAPIA, Lucia
21			18	LUCENA TAPIA, Lucia
13	CASASUS ROMERO, Jara	ARA	4	GUTIERREZ MOLINA, Ashley
29	GUTIERREZ MOLINA, Ashley	VAL	4	000 s1 / 110 2:06

POOL B

3			5	LOPEZ VAZQUEZ, Mara
19	LOPEZ VAZQUEZ, Mara	GAL	5	
11	SALAZAR RAMOS, Ainoa	CAN	6	SALAZAR RAMOS, Ainoa
27			19	SALAZAR RAMOS, Ainoa
7			7	LEON ANDRINO, Estibaliz
23	LEON ANDRINO, Estibaliz	MAD	7	
15	ANDUEZA ARRAIZ, Itxaso	NAV	8	CAZALLAS PERRONI, Laura
31	CAZALLAS PERRONI, Laura	CAT	8	000 / 110 0:57

POOL C

2	LAFUENTE DUQUE, Leire	NAV	9	LAFUENTE DUQUE, Leire
18			21	LAFUENTE DUQUE, Leire
10	RAMIREZ VICTORIA, Amparo	VAL	10	RAMIREZ VICTORIA, Amparo
26	DE SIMONE RECHA, Jessica	BAL	10	100 / 000 s3 1:58
6			11	NICOLAS NICOLAS, Ainhoa
22	NICOLAS NICOLAS, Ainhoa	MUR	11	
14	VASQUEZ DEL VAL, Victoria	CLE	12	VASQUEZ DEL VAL, Victoria
30	UJAQUE ROBLES, Miriam	AND	12	110 / 000 0:43

POOL D

4	MEDINA MORENO, Lucia	VAL	13	MEDINA MORENO, Lucia
20			23	MEDINA MORENO, Lucia
12			14	CABRERA COSTA, Eva
28	CABRERA COSTA, Eva	MAD	14	
8	GARCIA ROCCO, Katerina	CLM	15	GARCIA ROCCO, Katerina
24	MORENO ENTERRIA, Claudia	GAL	15	030 / 010 3:00
16			24	ETXABARRIA BILBAO, Eunate
32	ETXABARRIA BILBAO, Eunate	VAS	16	000 s1 / 100 1:13

Trostrunde / Repechage / Ronda de consolación

Repechage / Trostrunde / Repesca

[A1]			29	SOUTO GONZALEZ, Melania	33	SOUTO GONZALEZ, Melania
[A2]	SOUTO GONZALEZ, Melania	AST	29		33	100 / 000 2:54
[A3]				LUCENA TAPIA, Lucia		
[B1]			30	LOPEZ VAZQUEZ, Mara	34	LOPEZ VAZQUEZ, Mara
[B2]	LOPEZ VAZQUEZ, Mara	GAL	30		34	000 / 100 1:45
[B3]				LEON ANDRINO, Estibaliz		
[C1]			31	RAMIREZ VICTORIA, Amparo	35	RAMIREZ VICTORIA, Amparo
[C2]	RAMIREZ VICTORIA, Amparo	VAL	31		35	010 / 000 1:27
[C3]				NICOLAS NICOLAS, Ainhoa		
[D1]			32	GARCIA ROCCO, Katerina	40	RAMIREZ VICTORIA, Amparo
[D2]	GARCIA ROCCO, Katerina	CLM	32		40	010 / 000 2:26
[D3]				MEDINA MORENO, Lucia		
[D3]			36	GARCIA ROCCO, Katerina	42	SALAZAR RAMOS, Ainoa
[D3]			36		42	000 s3 / 100 1:48
[D3]				MEDINA MORENO, Lucia		
[D3]						

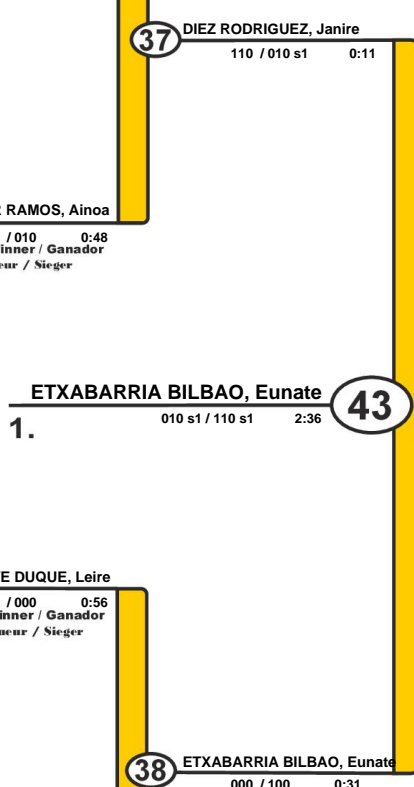

Results

Resultat / Platzierungen / Resultados

1. ETXABARRIA BILBAO, Eunate VAS
2. DIEZ RODRIGUEZ, Janire VAS
3. LAFUENTE DUQUE, Leire NAV
3. SALAZAR RAMOS, Ainoa CAN
5. LOPEZ VAZQUEZ, Mara GAL
5. RAMIREZ VICTORIA, Amparo VAL
7. SOUTO GONZALEZ, Melania AST
7. GARCIA ROCCO, Katerina CLM



Campeonato de España Escolar 2017

Valencia (ESP), 06-07 May 2017

+63Inf kg

25 Judoka

POOL A

1	KALINCHUK, Maria	VAL	1	KALINCHUK, Maria
17			17	KALINCHUK, Maria
9	JORGE MOLYTE, Manuela	GAL	2	JORGE MOLYTE, Manuela
25	VERA DIAZ, Maria	AND	2	110 / 000 s1 1:08
5	VIZOSO HERNANDEZ, Ana	MAD	3	VIZOSO HERNANDEZ, Ana
21	IGLESIAS DE LUCAS, Sara	CLE	3	100 / 000 0:11
13	LOPEZ COLLADO, Maria	AST	4	LOPEZ COLLADO, Maria
29			4	
			18	VIZOSO HERNANDEZ, Ana
			18	110 / 000 0:47

25 KALINCHUK, Maria
100 / 000 0:34
POOL A Winner / Ganador
Vainqueur / Sieger

POOL B

3			5	LOPEZ CARRASCO, Ainhoa
19	LOPEZ CARRASCO, Ainhoa	CAT	5	
11	CAJAL OROS, Alba	ARA	6	MELIAN HERNANDEZ, Aurora
27	MELIAN HERNANDEZ, Aurora	CAN	6	000 / 100 0:55
7	LOSILLA ARCE, Maria	MAD	7	LOSILLA ARCE, Maria
23			7	
15	MARIN BERDONCES, Adela	NAV	8	PEREZ CEBRINO, Mar
31	PEREZ CEBRINO, Mar	EXT	8	000 / 100 0:09
			19	LOPEZ CARRASCO, Ainhoa
			19	150 / 000 2:37
			20	PEREZ CEBRINO, Mar
			20	020 / 030 3:27

26 LOPEZ CARRASCO, Ainhoa
100 / 000 0:52
POOL B Winner / Ganador
Vainqueur / Sieger

POOL C

2	CUESTA MENEDEZ, Iria	AST	9	CUESTA MENEDEZ, Iria
18			9	
10	SORIANO MORON, Zoe	AND	10	SORIANO MORON, Zoe
26	TORRES CARDONA, Laura	BAL	10	120 / 000 s3 2:12
6	MARIN CONTE, Marina	MUR	11	MOROTE GUIJARRO, Alba
22	MOROTE GUIJARRO, Alba	VAL	11	000 / 100 0:16
14	HELMERKING SANCHEZ, Antoni	LM	12	COBOS LOPEZ, Miriam
30	COBOS LOPEZ, Miriam	MAD	12	000 / 100 1:12
			21	CUESTA MENEDEZ, Iria
			21	110 s1 / 010 2:42
			22	MOROTE GUIJARRO, Alba
			22	110 / 010 1:28

27 CUESTA MENEDEZ, Iria
110 / 000 s1 1:56
POOL C Winner / Ganador
Vainqueur / Sieger

POOL D

4	FERNANDEZ DIAZ, Noa	AST	13	FERNANDEZ DIAZ, Noa
20			13	
12	ESCOLAR GARCIA, Aiala	VAS	14	GARCIA SOLER, Nerea
28	GARCIA SOLER, Nerea	CAT	14	000 / 010 3:54
8			15	PRIETO ARENAS, Cynthia
24	PRIETO ARENAS, Cynthia	MAD	15	
16	SANCHEZ COBO, Andrea	CTB	16	INSUA IGLESIAS, Noelia
32	INSUA IGLESIAS, Noelia	GAL	16	000 / 110 0:40
			23	FERNANDEZ DIAZ, Noa
			23	010 / 000 4:19
			24	INSUA IGLESIAS, Noelia
			24	000 / 100 0:56

28 INSUA IGLESIAS, Noelia
000 / 100 0:06
POOL D Winner / Ganador
Vainqueur / Sieger

KALINCHUK, Maria
1.
040 / 000 s1 3:00
43

Results		
Resultat / Platzierungen / Resultados		
1.	KALINCHUK, Maria	VAL
2.	INSUA IGLESIAS, Noelia	GAL
3.	JORGE MOLYTE, Manuela	GAL
3.	SORIANO MORON, Zoe	AND
5.	CUESTA MENEDEZ, Iria	AST
5.	LOPEZ CARRASCO, Ainhoa	CAT
7.	MELIAN HERNANDEZ, Aurora	CAN
7.	FERNANDEZ DIAZ, Noa	AST

Trostrunde / Repechage / Ronda de consolación

[A1]			29	JORGE MOLYTE, Manuela	33	JORGE MOLYTE, Manuela	
[A2]	JORGE MOLYTE, Manuela	GAL	29		33	000 / 000 s2 1:25	
[B1]			30	MELIAN HERNANDEZ, Aurora	34	MELIAN HERNANDEZ, Aurora	
[B2]	MELIAN HERNANDEZ, Aurora	CAN	30		34	010 / 000 s1 2:44	
[C1]			31	SORIANO MORON, Zoe	35	SORIANO MORON, Zoe	
[C2]	SORIANO MORON, Zoe	AND	31		35	010 / 000 s1 2:08	
[D1]			32	PRIETO ARENAS, Cynthia	36	FERNANDEZ DIAZ, Noa	
[D2]	PRIETO ARENAS, Cynthia	MAD	32		36	000 s2 / 000 1:42	
						37	LOPEZ CARRASCO, Ainhoa
						37	000 / 010 2:54
						39	JORGE MOLYTE, Manuela
						39	010 / 000 s1 2:44
						40	SORIANO MORON, Zoe
						40	010 / 000 2:48
						41	JORGE MOLYTE, Manuela
						41	100 s1 / 000 1:47
						42	SORIANO MORON, Zoe
						42	110 / 010 s1 3:35



Campeonato de España Escolar 2017

Valencia (ESP), 06-07 May 2017

-40Cad kg

14 Judoka

POOL A

1	TORREGROSA PINA, Laura	VAL
9		
5	HERNANDEZ FLORES, Nayara	AND
13	RODRIGUEZ ROLDAN, Andrea	MAD

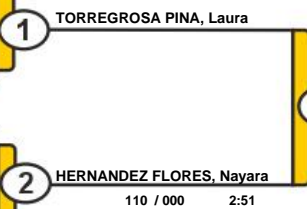

9 TORREGROSA PINA, Laura
110 / 000 0:31
POOL A Winner / Ganador
Vainqueur / Sieger

POOL B

3	MAYORDOMO GARCIA, Carmen	MAD
11	NUEZ ROMERO, Marta	CAN
7	PEREZ SOMOZA, Paula	GAL
15	CASTRO FERNANDEZ, Itziar	MAD

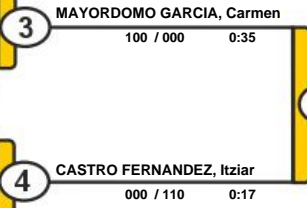

10 MAYORDOMO GARCIA, Carmen
110 / 000 sH 2:22
POOL B Winner / Ganador
Vainqueur / Sieger

POOL C

2	PRADOS BARBERO, Maria	AND
10		
6	FONTECHA MUNOZ, Olga	CLE
14	SANCHEZ MARTINEZ, Paola	MAD

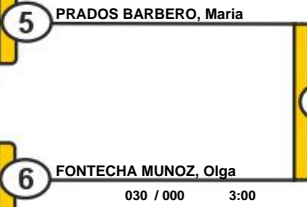

11 PRADOS BARBERO, Maria
020 s1 / 000 3:00
POOL C Winner / Ganador
Vainqueur / Sieger

POOL D

4	CORREJES GREGORIO, Lidia	VAL
12	HERNANDO SANCHEZ, Pilar	MAD
8	MEDICES VEGA, Delia	VAS
16	EJAZ GARCIA, Aixa	CAT

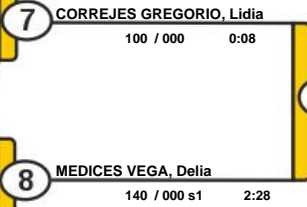

12 MEDICES VEGA, Delia
000 s2 / 000 s1 3:03
POOL D Winner / Ganador
Vainqueur / Sieger



1.

18

Results		
Resultat / Platzierungen / Resultados		
1.	TORREGROSA PINA, Laura	VAL
2.	PRADOS BARBERO, Maria	AND
3.	CASTRO FERNANDEZ, Itziar	MAD
5.	MAYORDOMO GARCIA, Carmen	MAD
5.	MEDICES VEGA, Delia	VAS
7.	CORREJES GREGORIO, Lidia	VAL
7.	HERNANDEZ FLORES, Nayara	AND
7.	FONTECHA MUNOZ, Olga	CLE

Trostrunde / Repechage / Ronda de consolación

Repechage / Trostrunde / Repesca

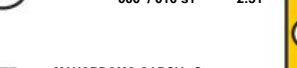
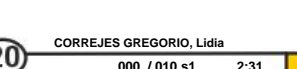
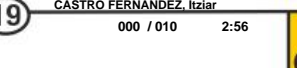
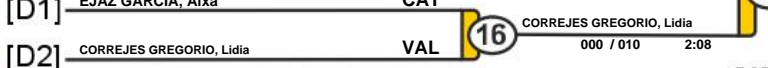
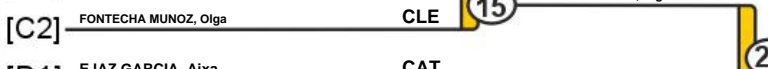
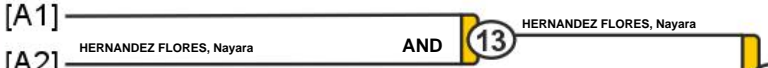

3.

3.



Campeonato de España Escolar 2017

Valencia (ESP), 06-07 May 2017

-44Cad kg

19 Judoka

POOL A

1	FARELO GONZALEZ, Nuria	BAL	1	FARELO GONZALEZ, Nuria
17				
9			2	GRANDA RAMOS, Nerea
25	GRANDA RAMOS, Nerea	AST		
5	GONZALEZ FERNAN, Claudia	AND	3	GONZALEZ FERNAN, Claudia
21				
13	MORENO DE LA LLAVE, Maria	MAD	4	MORENO DE LA LLAVE, Maria
29	MURILLO BALDOMINOS, Maria	ARA		

17	FARELO GONZALEZ, Nuria	100 / 000	0:48
25	FARELO GONZALEZ, Nuria	010 / 000 s2	3:00
18	MORENO DE LA LLAVE, Maria	010 / 110	2:31
18	MORENO DE LA LLAVE, Maria	000 / 000 s1	7:07

POOL B

3	BARANDIARAN BARREIRO, Eider	VAS	5	BARANDIARAN BARREIRO, Eider
19				
11			6	OSTERIZ LARA, Marta
27	OSTERIZ LARA, Marta	NAV		
7			7	GARRIGA ORTEGA, Marina
23	GARRIGA ORTEGA, Marina	CAT		
15			8	ALVAREZ SUEIRO, Jimena
31	ALVAREZ SUEIRO, Jimena	MAD		

19	BARANDIARAN BARREIRO, Eider	100 / 000	0:06
26	GARRIGA ORTEGA, Marina	000 / 110 s1	1:40
20	GARRIGA ORTEGA, Marina	100 / 000 s2	2:49

POOL C

2	RODRIGUEZ SALVADOR, Mireia	VAL	9	RODRIGUEZ SALVADOR, Mireia
18				
10	NORIEGA BARRIONUEVO, Elena	MUR	10	ROJAS GONZALEZ, Maria
26	ROJAS GONZALEZ, Maria	MAD		
6	CID BALCELLS, Jana	CAT	11	CID BALCELLS, Jana
22				
14			12	MULERO, Aisha
30	MULERO, Aisha	BAL		

21	RODRIGUEZ SALVADOR, Mireia	010 / 000	3:00
27	RODRIGUEZ SALVADOR, Mireia	100 / 000	1:53
22	CID BALCELLS, Jana	100 / 000	0:11

POOL D

4	HERNANDEZ FLORES, Nazaret	AND	13	HERNANDEZ FLORES, Nazaret
20				
12	GAMAZO DUQUE, Maria	MAD	14	GAMAZO DUQUE, Maria
28	ALBORNOZ GONZALEZ, Sofia	CAN		
8	LORENZO RODERO, Alba	CLE	15	LORENZO RODERO, Alba
24				
16			16	RODRIGUEZ CARBALLO, Lucia
32	RODRIGUEZ CARBALLO, Lucia	GAL		

23	HERNANDEZ FLORES, Nazaret	100 / 000	0:33
28	HERNANDEZ FLORES, Nazaret	100 / 000	0:45
24	RODRIGUEZ CARBALLO, Lucia	000 / 130 s1	1:56

RODRIGUEZ SALVADOR, Mireia 43

1.

43	RODRIGUEZ SALVADOR, Mireia	000 / 110	1:07
37	GARRIGA ORTEGA, Marina	000 / 100	1:00
26	GARRIGA ORTEGA, Marina	000 / 110 s1	1:40
38	RODRIGUEZ SALVADOR, Mireia	110 / 000 s1	1:43

Results	
Resultat / Platzierungen / Resultados	
1.	RODRIGUEZ SALVADOR, Mireia VAL
2.	GARRIGA ORTEGA, Marina CAT
3.	BARANDIARAN BARREIRO, Eider VAS
3.	RODRIGUEZ CARBALLO, Lucia GAL
5.	HERNANDEZ FLORES, Nazaret AND
5.	FARELO GONZALEZ, Nuria BAL
7.	MORENO DE LA LLAVE, Maria MAD
7.	ROJAS GONZALEZ, Maria MAD

Trostrunde / Repechage / Ronda de consolación

Repechage / Trostrunde / Repechage

[A1]			29	GRANDA RAMOS, Nerea	33	MORENO DE LA LLAVE, Maria
[A2]	GRANDA RAMOS, Nerea	AST			[A3]	MORENO DE LA LLAVE, Maria
[B1]			30	ALVAREZ SUEIRO, Jimena	34	BARANDIARAN BARREIRO, Eider
[B2]	ALVAREZ SUEIRO, Jimena	MAD			[B3]	BARANDIARAN BARREIRO, Eider
[C1]			31	ROJAS GONZALEZ, Maria	35	ROJAS GONZALEZ, Maria
[C2]	ROJAS GONZALEZ, Maria	MAD			[C3]	CID BALCELLS, Jana
[D1]			32	GAMAZO DUQUE, Maria	36	RODRIGUEZ CARBALLO, Lucia
[D2]	GAMAZO DUQUE, Maria	MAD			[D3]	RODRIGUEZ CARBALLO, Lucia

39	BARANDIARAN BARREIRO, Eider	000 / 010	2:52
41	BARANDIARAN BARREIRO, Eider	100 / 000 s3	3:19
[38]	HERNANDEZ FLORES, Nazaret		
40	RODRIGUEZ CARBALLO, Lucia	000 / 010	2:53
42	RODRIGUEZ CARBALLO, Lucia	100 / 000	2:02
[37]	FARELO GONZALEZ, Nuria		



Campeonato de España Escolar 2017

Valencia (ESP), 06-07 May 2017

-48Cad kg

26 Judoka

POOL A

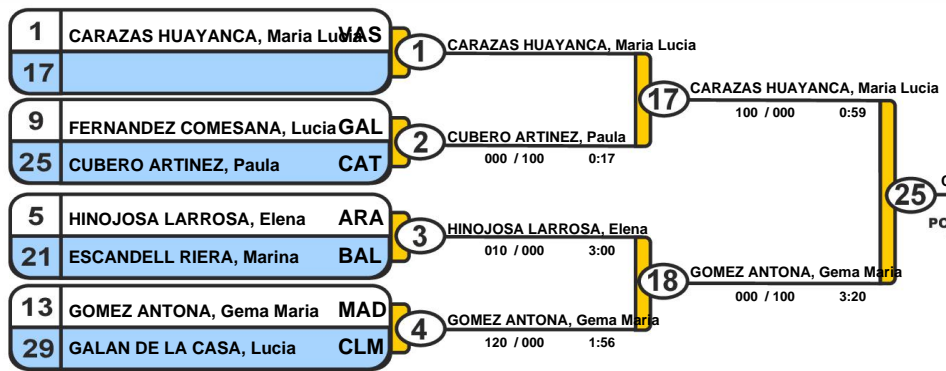

POOL B

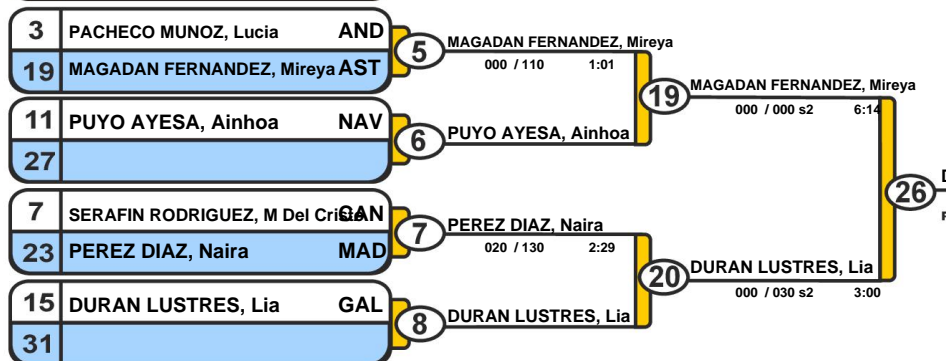

POOL C

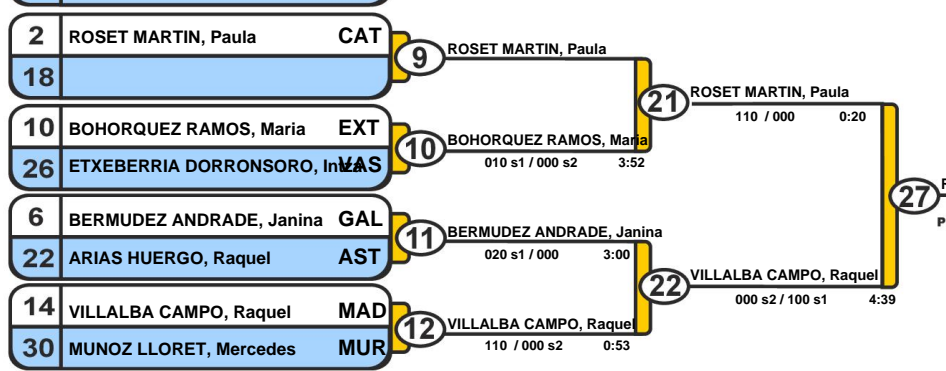

POOL D

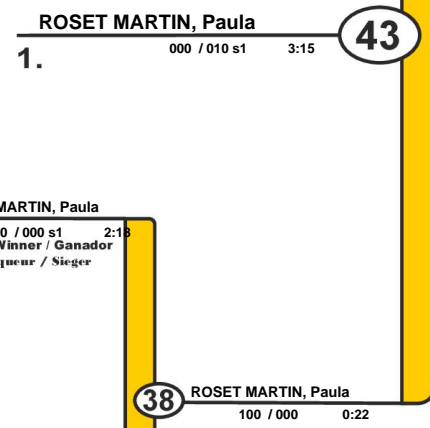
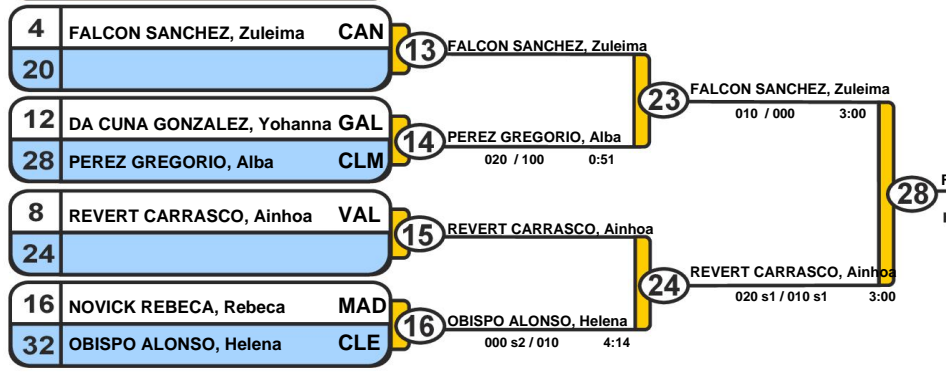

Results		
Resultat / Platzierungen / Resultados		
1.	ROSET MARTIN, Paula	CAT
2.	CARAZAS HUAYANCA, Maria Lucia	VAS
3.	GOMEZ ANTONA, Gema Maria	MAD
3.	VILLALBA CAMPO, Raquel	MAD
5.	FALCON SANCHEZ, Zuleima	CAN
5.	DURAN LUSTRES, Lia	GAL
7.	MAGADAN FERNANDEZ, Mireya	AST
7.	PEREZ GREGORIO, Alba	CLM

Trostrunde / Repechage / Ronda de consolación

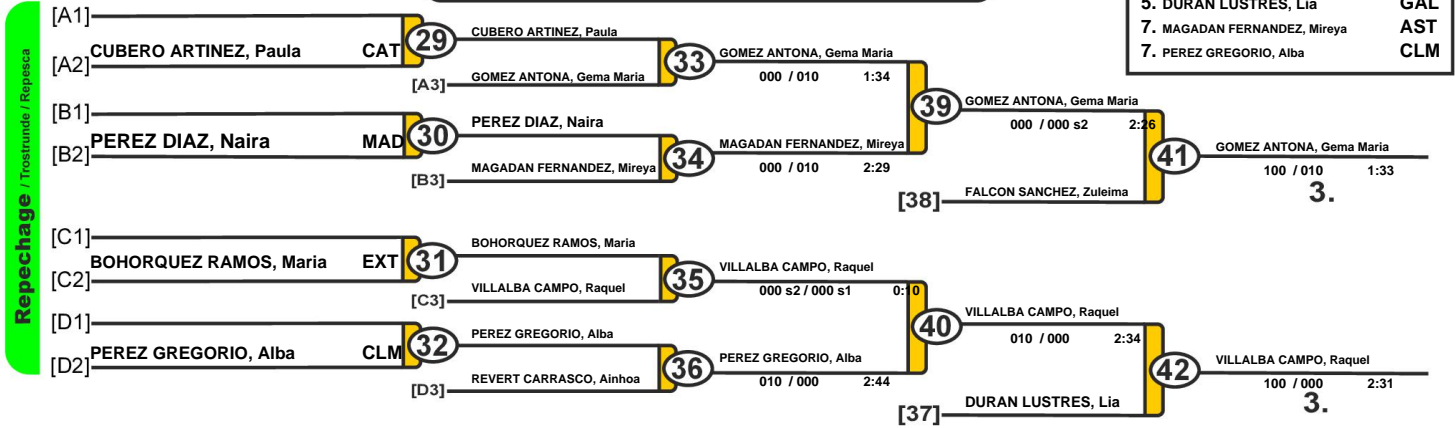



Campeonato de España Escolar 2017

Valencia (ESP), 06-07 May 2017

-52Cad kg

28 Judoka

POOL A

1	MARTIN GALLARDO, Patricia	MAD	1	MARTIN GALLARDO, Patricia
17			17	MARTIN GALLARDO, Patricia
9	CASTELLO DIEZ, Marina	VAL	2	CASTELLO DIEZ, Marina
25	CATALAN HONRUBIA, Laura	CLM	2	110 / 000 1:18
5	CALVO JAROSO, Claudia	MAD	3	CALVO JAROSO, Claudia
21	GUDE VILA, Lidia	GAL	3	100 / 000 sH 2:52
13	GOMARIZ MORENILLA, Amparo	MUR	4	AGUDO HUERTA, Daniela
29	AGUDO HUERTA, Daniela	CLE	4	000 s1 / 110 1:19

POOL B

3			5	FERNANDEZ RIVERO, Virginia
19	FERNANDEZ RIVERO, Virginia	AND	5	FERNANDEZ RIVERO, Virginia
11	NIETO BOILLOS, Luna	ARA	6	GARCIA JURADO, Ana
27	GARCIA JURADO, Ana	CAT	6	000 s1 / 020 s1 3:00
7	GIL ALONSO, Carla	VAL	7	GIL ALONSO, Carla
23	GARCIA MARTIN, Marta	MAD	7	010 s2 / 000 s1 3:00
15	VEGA MUNIZ, Valeria	CTB	8	VEGA MUNIZ, Valeria
31	ARRIBAS GUTIERREZ, Silvia	NAV	8	100 / 000 1:30

POOL C

2	MUNOZ SOLANO, Lucia	MAD	9	MUNOZ SOLANO, Lucia
18			9	MUNOZ SOLANO, Lucia
10	LAGOS REVILLA, Agustina	RIO	10	MARTINEZ LLORET, Leyre
26	MARTINEZ LLORET, Leyre	NAV	10	000 s3 / 120 2:07
6	ROSA CANO, Noelia Ana	VAL	11	SANCHEZ SILVA, Ainara
22	SANCHEZ SILVA, Ainara	CAN	11	000 / 010 4:07
14	LOPEZ DIAZ, Ana Maria	AND	12	CHANES MARTINEZ, Laura
30	CHANES MARTINEZ, Laura	BAL	12	000 / 100 0:16

POOL D

4	CAMPUZANO PEREZ, Marta	CLM	13	CAMPUZANO PEREZ, Marta
20			13	CAMPUZANO PEREZ, Marta
12	GONZALO ALVAREZ, Mailen	VAS	14	MARTIN GIL, Alicia
28	MARTIN GIL, Alicia	MAD	14	000 s1 / 020 3:00
8	RAMIREZ GIMENEZ, Sandra	ARA	15	RAMIREZ GIMENEZ, Sandra
24	GARCIA LAZARO, Maria Teresa	EXT	15	020 / 000 s1 3:00
16	ESTRADA MUNIZ, Maria	AST	16	GONZALEZ TOLEDO, Lorena
32	GONZALEZ TOLEDO, Lorena	MAD	16	000 / 120 0:32

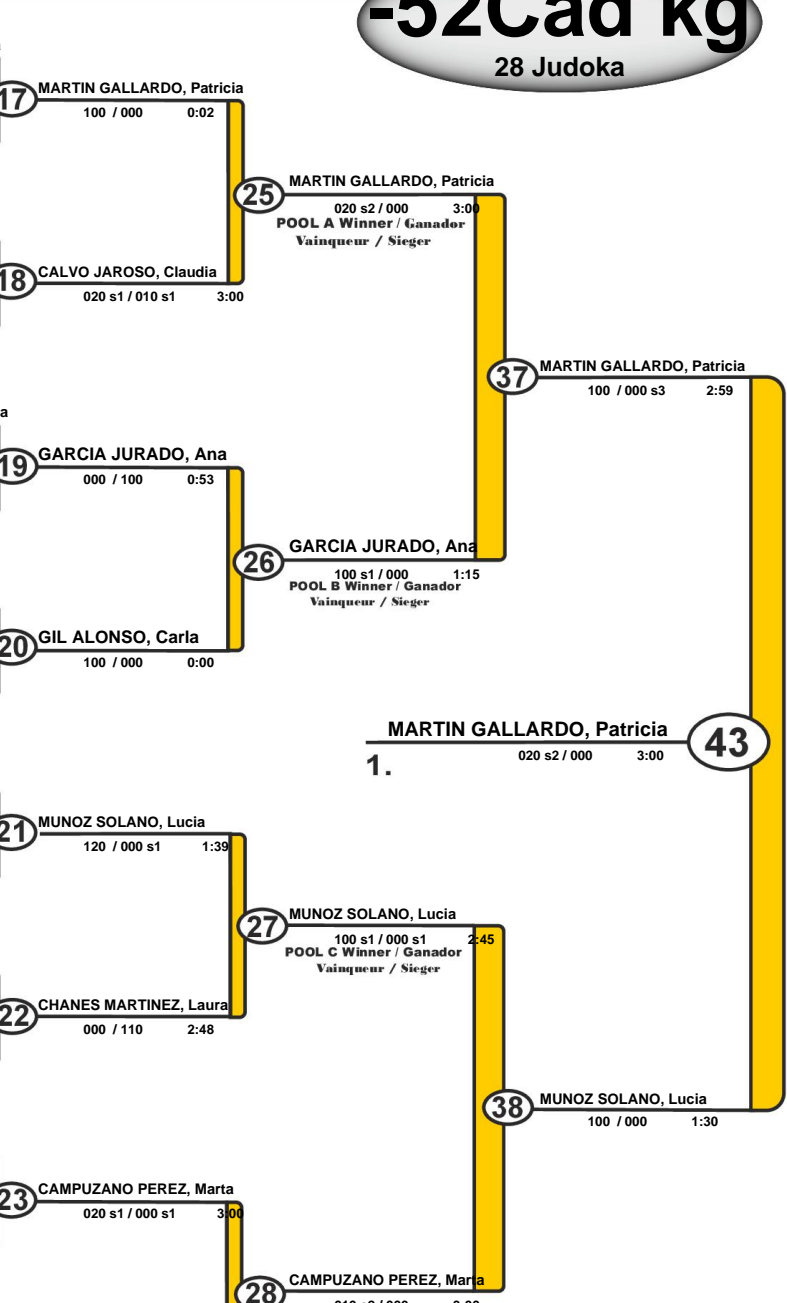

Trostrunde / Repechage / Ronda de consolación

Repechage / Trostrunde / Repesca

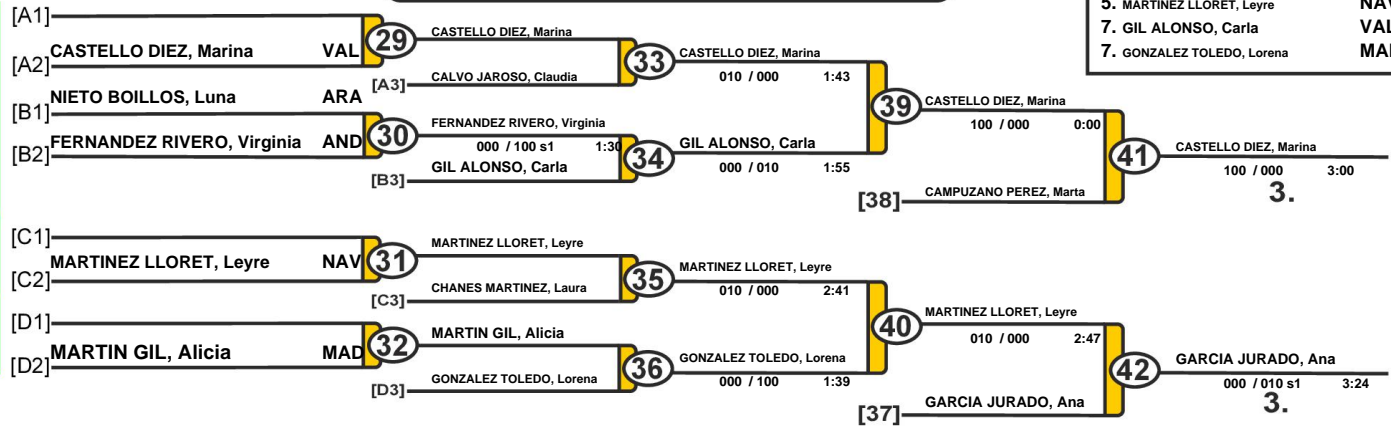

Results		
Resultat / Platzierungen / Resultados		
1.	MARTIN GALLARDO, Patricia	MAD
2.	MUNOZ SOLANO, Lucia	MAD
3.	CASTELLO DIEZ, Marina	VAL
3.	GARCIA JURADO, Ana	CAT
5.	CAMPUZANO PEREZ, Marta	CLM
5.	MARTINEZ LLORET, Leyre	NAV
7.	GIL ALONSO, Carla	VAL
7.	GONZALEZ TOLEDO, Lorena	MAD



Campeonato de España Escolar 2017

Valencia (ESP), 06-07 May 2017

-57Cad kg

32 Judoka

POOL A

1	OLIVER FERRA, Maria	BAL
17	LORENTE INSUA, Andrea	MAD
9	GOMEZ SANMIGUEL, Candela	VAL
25	PEREZ COLLAZO, Eva	RIO
5	DIAZ ALBERT, Ana	AND
21	BALLESTEROS CAMPANO, Gemma	CAT
13	BLANCO ALONSO, Sofia	AST
29	ORTEGA INFANTE, Andrea	CAN

POOL B

3	CARO CARO, Sara	CLM
19	MARTIN CORREA, Lucia	MUR
11	DASGUPTA, Aakriti	CAT
27	JUAN MARTINEZ, Alba	MAD
7	GALLAN LACRUZ, Carmen	ARA
23	CARBALLEIRA BAHAMONDE, Laura	GAL
15	DURANTE MARTINEZ, Alicia	CLE
31	GIL ALONSO, Angela	VAL

POOL C

2	VAZQUEZ FERNANDEZ, Laura	GAL
18	RUIZ LOPEZ, Lorena	EXT
10	GUTIERREZ GONZALEZ, Lara	CAN
26	BORDA ZUMETA, Irati	VAS
6	FERNANDEZ LOPEZ, Pilar	MAD
22	ORVAY SENEN, Natalia	BAL
14	MERINO VICENTE, Leyre	NAV
30	GONZALEZ GARCIA, Laura	CTB

POOL D

4	BUCUR, Alicia Carmen	RIO
20	ARAIZ SANCHO, Cristina	VAL
12	GARCIA RODRIGUEZ, Susana	AND
28	LANZAT ALBALADEJO, Andrea	MAD
8	LOPEZ SEOANE, Sara	GAL
24	RODRIGUEZ PEREZ, Angels	CAT
16	TANAKA ANGULO, Natsumi	CAN
32	LOPEZ GUARINOS, Miriam Del Mar	M&LM

Trostrunde / Repechage / Ronda de consolación

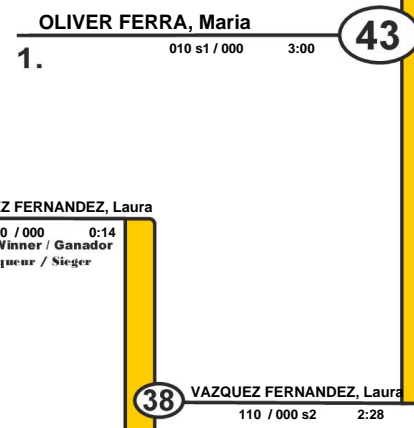
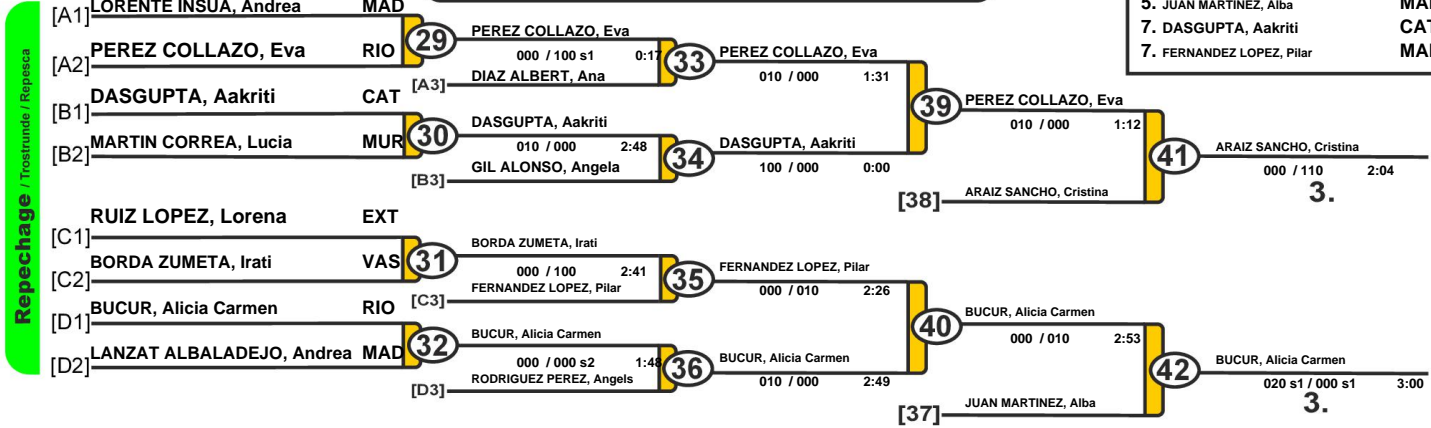

Results		
Resultat / Platzierungen / Resultados		
1.	OLIVER FERRA, Maria	BAL
2.	VAZQUEZ FERNANDEZ, Laura	GAL
3.	ARAIZ SANCHO, Cristina	VAL
3.	BUCUR, Alicia Carmen	RIO
5.	PEREZ COLLAZO, Eva	RIO
5.	JUAN MARTINEZ, Alba	MAD
7.	DASGUPTA, Aakriti	CAT
7.	FERNANDEZ LOPEZ, Pilar	MAD



Campeonato de España Escolar 2017

Valencia (ESP), 06-07 May 2017

-63Cad kg

28 Judoka

POOL A

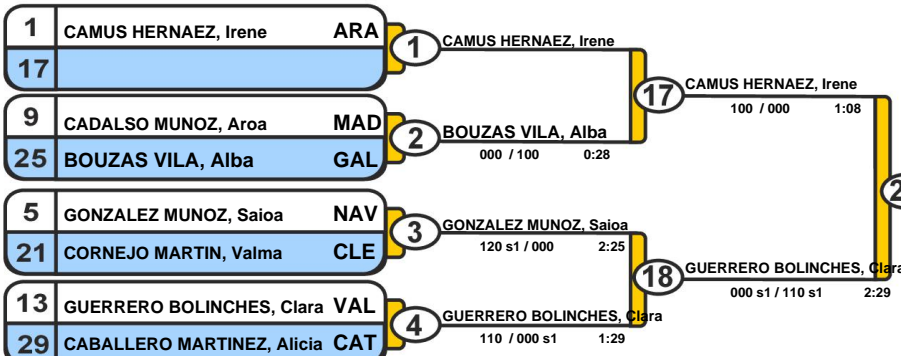

POOL B

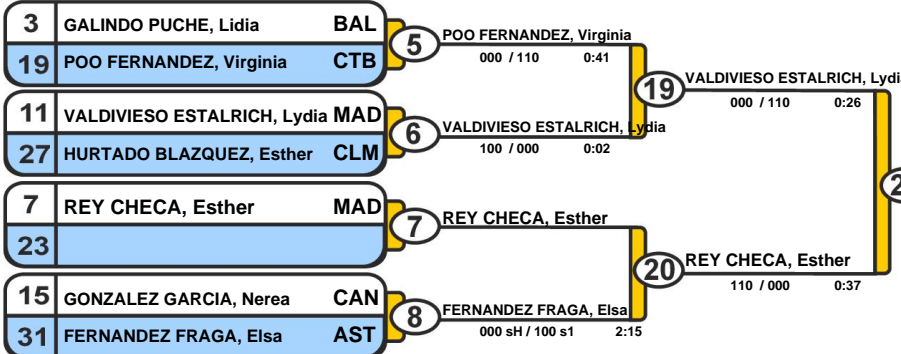

POOL C

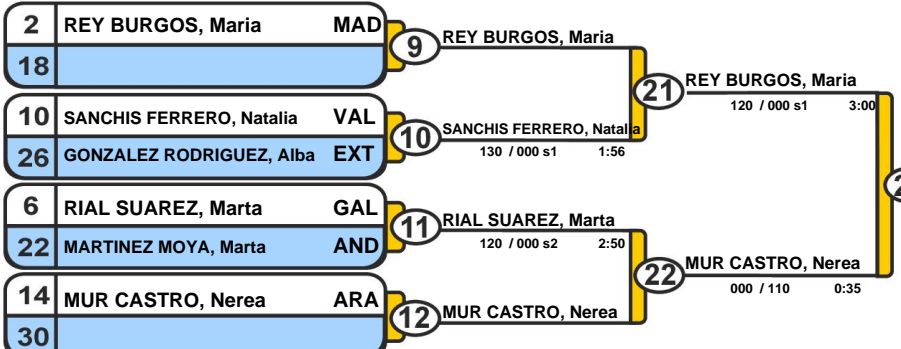

POOL D

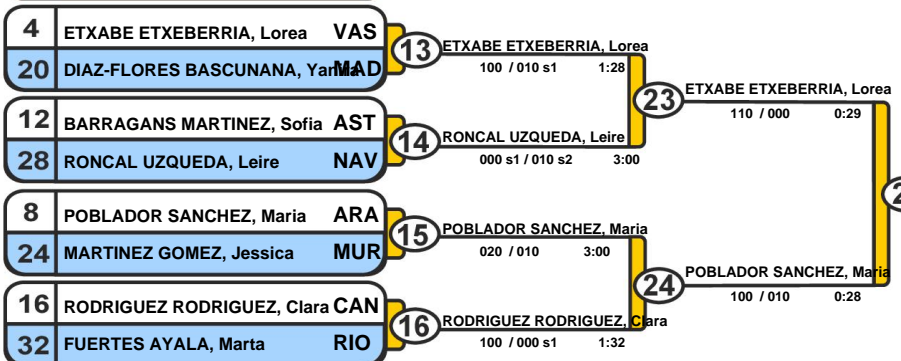

Trostrunde / Repechage / Ronda de consolación

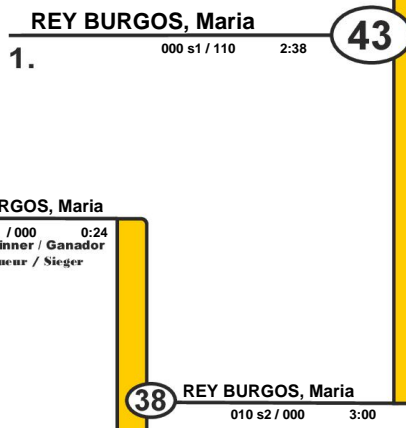
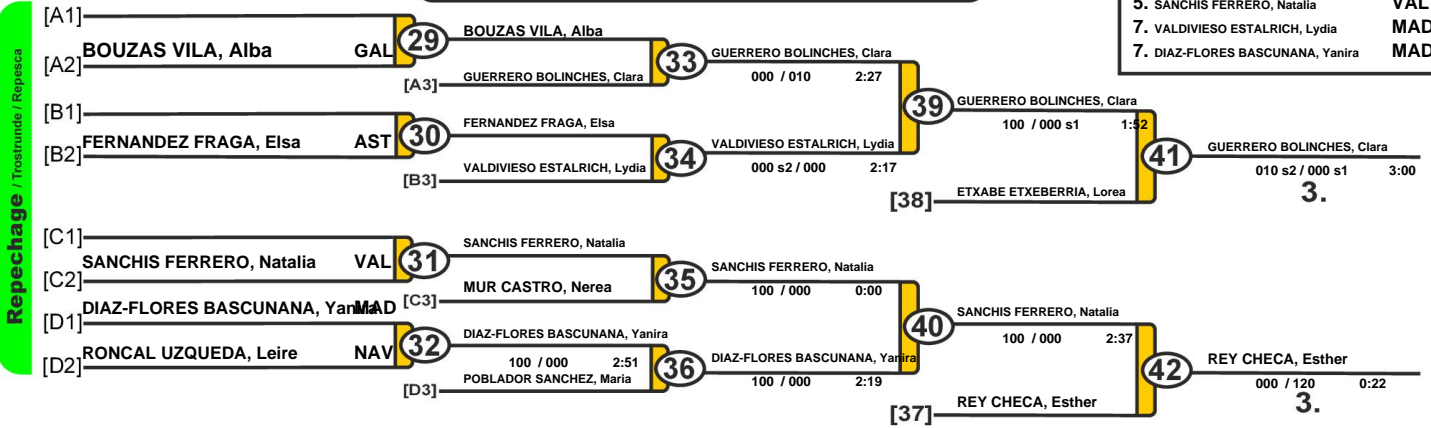

Results		
Resultat / Platzierungen / Resultados		
1.	REY BURGOS, Maria	MAD
2.	CAMUS HERNAEZ, Irene	ARA
3.	GUERRERO BOLINCHES, Clara	VAL
3.	REY CHECA, Esther	MAD
5.	ETXABE ETXEBERRIA, Lorea	VAS
5.	SANCHIS FERRERO, Natalia	VAL
7.	VALDIVIESO ESTALRICH, Lydia	MAD
7.	DIAZ-FLORES BASCUNANA, Yanira	MAD



Campeonato de España Escolar 2017

Valencia (ESP), 06-07 May 2017

-70Cad kg

26 Judoka

POOL A

1	DAVILA MONTOYA, Sara	MAD
17		
9	WOOD PIZA, Nina Jade	BAL
25	FISHER, Natalia	AND
5		
21	MARTINEZ RUEDA, Maria	RIO
13	POURZAND SAMDJEDEN, Soray	MAD
29	GONZALEZ DOMINGUEZ, Yailen	CAN

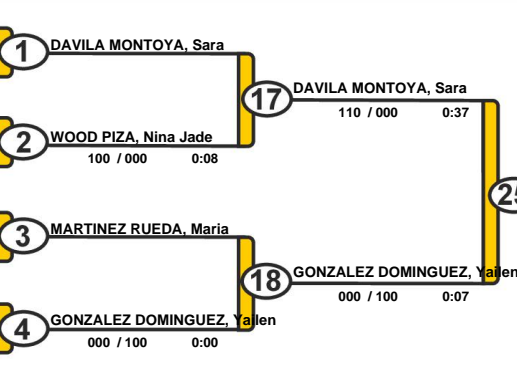

POOL B

3	MELENDEZ DEL POZO, Julia	CLE
19	BONE IBANEZ, Ines	VAL
11	GARCIA GALAN, Lucia	AST
27	PINTADO GALLARDO, Cristina	MAD
7	PUENTE REVENGA, Ruth Maria	CTB
23	DEL MORAL MARTI, Lourdes	CAT
15		
31	RUA PRADO, Maria	GAL

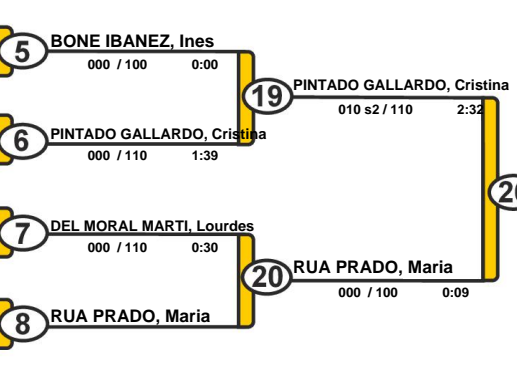

POOL C

2	SOTILLO GOMEZ, Begona	MAD
18		
10	SANTAMARIA ARACAMA, Paula	VAS
26	CATALAN SALAS, Elena	ARA
6	DEVORA ILUNDAIN, Ana	NAV
22	NYBERG, Milena Gabriela	AND
14	ROVELLADA VINENT, Lluçia	BAL
30	ESTEBAN DE LA IGLESIA, Lucia	MAD

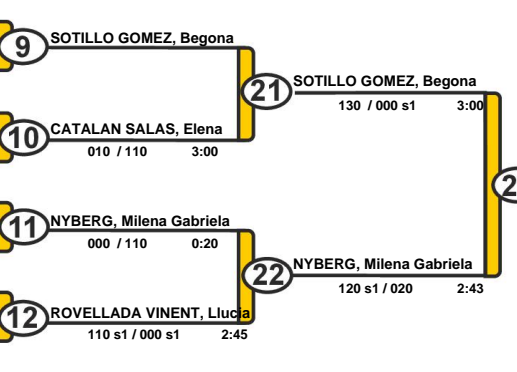

POOL D

4	REY CHECA, Alba	MAD
20		
12	LOPEZ FERRER, Triana	MUR
28	CHEMLAL HASSAN, Omaila	CAN
8	ASENSIO ORTIZ, Rocio	EXT
24	TSUNODA, Ai	CAT
16	CADALSO LOPEZ, Sara	CLM
32		

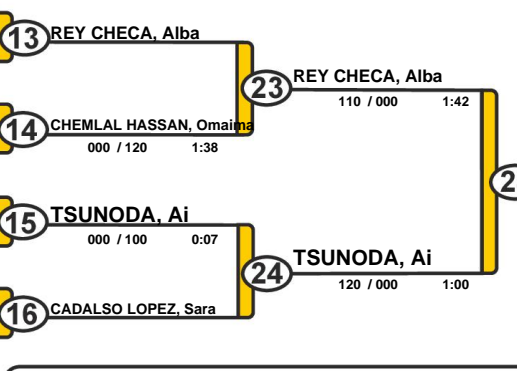

TSUNODA, Ai 43
1. 000 / 110 0:57

Results		
Resultat / Platzierungen / Resultados		
1.	TSUNODA, Ai	CAT
2.	DAVILA MONTOYA, Sara	MAD
3.	SOTILLO GOMEZ, Begona	MAD
3.	PINTADO GALLARDO, Cristina	MAD
5.	BONE IBANEZ, Ines	VAL
5.	REY CHECA, Alba	MAD
7.	GONZALEZ DOMINGUEZ, Yailen	CAN
7.	CATALAN SALAS, Elena	ARA

Trostrunde / Repechage / Ronda de consolación

Repechage / Trostrunde / Repesca

[A1]			
[A2]	WOOD PIZA, Nina Jade	BAL	29
[B1]	GARCIA GALAN, Lucia	AST	
[B2]	BONE IBANEZ, Ines	VAL	30
[C1]	CATALAN SALAS, Elena	ARA	31
[C2]	ASSENSIO ORTIZ, Rocio	EXT	
[D1]	CADALSO LOPEZ, Sara	CLM	32
[D2]	REY CHECA, Alba		

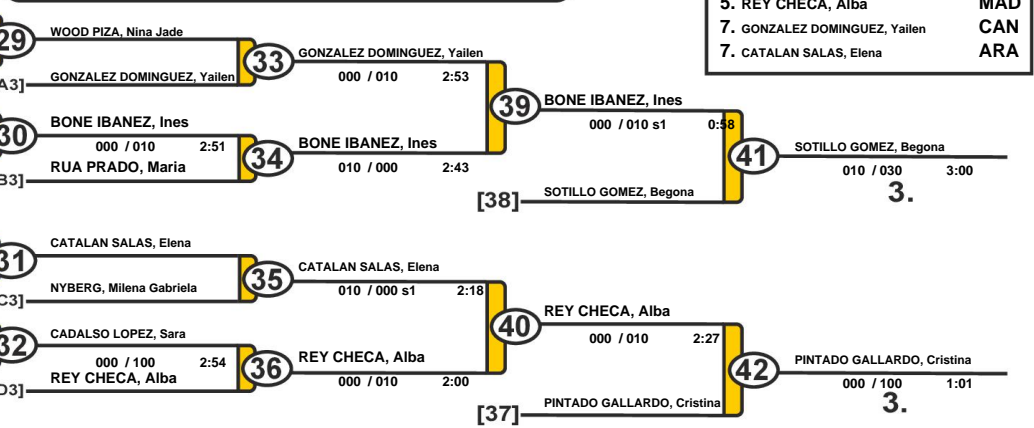



Campeonato de España Escolar 2017

Valencia (ESP), 06-07 May 2017

+70Cad kg

23 Judoka

POOL A

1 SUAREZ CABRERA, Dayami CAN
17

1 SUAREZ CABRERA, Dayami

9 MUNOZ PEREZ, Ane VAS
25 RODRIGUEZ RODRIGUEZ, Sara AST

2 MUNOZ PEREZ, Ane
120 / 000 1:20

17 SUAREZ CABRERA, Dayami
120 / 000 0:20

5
21 OVILO REYES, Sonia MAD

3 OVILO REYES, Sonia

25 SUAREZ CABRERA, Dayami
100 / 000 0:20
POOL A Winner / Ganador
Vainqueur / Sieger

13 CASADO LOPEZ, Elena CLE
29 RUIZ DIAZ, Andrea AND

4 CASADO LOPEZ, Elena
010 / 000 s1 3:00

18 OVILO REYES, Sonia
110 / 000 1:08

POOL B

3 DAZA VILLA, Paula MAD
19 REMIREZ MARTINEZ, Alejandra RIO

5 DAZA VILLA, Paula
130 / 000 1:56

37 SUAREZ CABRERA, Dayami
110 / 000 0:37

11
27 SANSEBASTIAN SILVA, Beatriz VAL

6 SANSEBASTIAN SILVA, Beatriz

19 DAZA VILLA, Paula
110 / 010 2:14

7 HEREDIA REYES, Maria Jose MAD
23 SALGADO LOPEZ, Claudia CAT

7 HEREDIA REYES, Maria Jose
010 s2 / 000 3:00

26 DAZA VILLA, Paula
010 / 000 3:26
POOL B Winner / Ganador
Vainqueur / Sieger

15
31 GONZALEZ GARCIA, Arantxa CLM

8 GONZALEZ GARCIA, Arantxa

20 HEREDIA REYES, Maria Jose
110 / 000 0:32

POOL C

2 BOUSBAA DAB, Nisrim MAD
18

9 BOUSBAA DAB, Nisrim

FERNANDEZ CAMPILLO, Sara
1.
000 s3 / 110 s2 2:41
43

10 CASANOVA NOVOA, Andrea GAL
26 MARTINEZ SANCHEZ, Anna CAT

10 MARTINEZ SANCHEZ, Anna
000 / 110 1:22

21 BOUSBAA DAB, Nisrim
130 / 000 2:36

6 DIAZ CANTOS, Ohiana VAS
22 ELIZAGA LARA, Anne NAV

11 DIAZ CANTOS, Ohiana
100 / 000 0:11

27 DIAZ CANTOS, Ohiana
010 / 100 1:34
POOL C Winner / Ganador
Vainqueur / Sieger

14 NUNEZ MOLINA, Sonia CAN
30

12 NUNEZ MOLINA, Sonia

22 DIAZ CANTOS, Ohiana
110 / 000 0:44

POOL D

4 CORNELLA BUJALDON, Aina CAT
20

13 CORNELLA BUJALDON, Aina

38 FERNANDEZ CAMPILLO, Sara
000 s3 / 100 2:12

12
28 ORTIZ AYALA, Patricia AND

14 ORTIZ AYALA, Patricia

23 CORNELLA BUJALDON, Aina
100 / 000 0:35

8
24 GARCIA BURGOS, Carmen BAL

15 GARCIA BURGOS, Carmen

28 FERNANDEZ CAMPILLO, Sara
000 s3 / 100 1:14
POOL D Winner / Ganador
Vainqueur / Sieger

16 FERNANDEZ VAYA, Eva VAL
32 FERNANDEZ CAMPILLO, Sara MAD

16 FERNANDEZ CAMPILLO, Sara
000 s1 / 120 1:12

24 FERNANDEZ CAMPILLO, Sara
000 / 100 0:37

Trostrunde / Repechage / Ronda de consolación

Repechage / Trostrunde / Repesca

[A1] MUNOZ PEREZ, Ane VAS
[A2] 29 MUNOZ PEREZ, Ane

29 MUNOZ PEREZ, Ane

33 MUNOZ PEREZ, Ane
010 / 000 2:46

[B1] REMIREZ MARTINEZ, Alejandra RIO
[B2] SANSEBASTIAN SILVA, Beatriz VAL

[A3] OVILO REYES, Sonia

30 SANSEBASTIAN SILVA, Beatriz
000 / 010 2:35

34 HEREDIA REYES, Maria Jose
000 / 010 2:41

39 HEREDIA REYES, Maria Jose
000 s1 / 010 1:39

[C1] ELIZAGA LARA, Anne NAV
[C2] NUNEZ MOLINA, Sonia CAN

[B3] HEREDIA REYES, Maria Jose

41 HEREDIA REYES, Maria Jose
120 / 000 1:00

[38] DIAZ CANTOS, Ohiana
3.

[D1] FERNANDEZ VAYA, Eva VAL
[D2] GARCIA BURGOS, Carmen BAL

[C3] BOUSBAA DAB, Nisrim

32 FERNANDEZ VAYA, Eva
010 / 000 2:45

35 BOUSBAA DAB, Nisrim
000 / 100 0:58

[40] CORNELLA BUJALDON, Aina
000 / 010 1:44

[D3] GARCIA BURGOS, Carmen BAL

[D3] CORNELLA BUJALDON, Aina

36 CORNELLA BUJALDON, Aina
000 / 010 2:26

[42] CORNELLA BUJALDON, Aina
010 s2 / 000 s1 3:00

[37] DAZA VILLA, Paula
3.

Results

Resultat / Platzierungen / Resultados		
1.	FERNANDEZ CAMPILLO, Sara	MAD
2.	SUAREZ CABRERA, Dayami	CAN
3.	HEREDIA REYES, Maria Jose	MAD
3.	CORNELLA BUJALDON, Aina	CAT
5.	DIAZ CANTOS, Ohiana	VAS
5.	DAZA VILLA, Paula	MAD
7.	MUNOZ PEREZ, Ane	VAS
7.	BOUSBAA DAB, Nisrim	MAD



Campeonato de España Escolar 2017

Valencia (ESP), 06-07 May 2017

Medallas

Totales

			1st place	2nd place	3rd place	5th place	7th place
1.		MAD Madrid	9	2	18	12	21
2.		VAL Valencia	8	4	9	12	5
3.		CAT Catalunya	7	2	6	10	5
4.		VAS Pais Vasco	2	4	5	4	4
5.		GAL Galicia	2	4	3	3	5
6.		NAV Navarra	2	3	5	3	1
7.		BAL Baleares	1	3	1	1	1
8.		ARA Aragon	1	1	1	3	3
9.		AST Asturias	1	0	2	1	7
10.		AND Andalucía		6	2	3	1
11.		CAN Canarias		2	3	4	4
12.		CLM Castilla la Mancha		1	1	2	4
13.		EXT Extremadura		1	0	0	0
14.		RIO Rioja			4	5	0
15.		CLE Castilla y León			4	2	3
16.		CTB Cantabria			1	1	0
17.		MUR Murcia			1	0	2

